



---

## DIRECTPATH™ STEREO LINE DRIVER, ADJUSTABLE GAIN

---

### FEATURES

- External Gain Setting Resistors
- Space Saving Package
  - 20-Pin, 4 mm × 4 mm Thin QFN, Thermally Optimized PowerPAD™ Package
- Ground-Referenced Outputs Eliminate DC-Blocking Capacitor
  - Reduce Board Area
  - Reduce Component Cost
  - Improve THD+N Performance
  - No Degradation of Low-Frequency Response Due to Output Capacitors
- Wide Power Supply Range: 1.8 V to 4.5 V
- 2 Vrms/Ch Output Voltage into 600 Ω at 3.3 V supply

- Independent Right and Left Channel Shutdown Control
- Short-Circuit and Thermal Protection
- Pop Reduction Circuitry

### APPLICATIONS

- Set-Top Boxes
- CD / DVD Players
- DVD-Receivers
- HTIB
- PDP / LCD TV's

### DESCRIPTION

The DRV601 is a stereo line driver designed to allow the removal of the output dc-blocking capacitors for reduced component count and cost. The device is ideal for single supply electronics where size and cost are critical design parameters.

The DRV601 is capable of driving 2 Vrms into a 600-Ω load at 3.3 V. The device has external gain setting resistors, that support a gain range of -1V/V to -10V/V, and line outputs that has ±8-kV IEC ESD protection. The device has independent shutdown control for the right and left audio channels.

The DRV601 is available in a 4 mm × 4 mm Thin QFN package.



Please be aware that an important notice concerning availability, standard warranty, and use in critical applications of Texas Instruments semiconductor products and disclaimers thereto appears at the end of this data sheet.

DIRECTPATH, PowerPAD, DirectPath are trademarks of Texas Instruments.



These devices have limited built-in ESD protection. The leads should be shorted together or the device placed in conductive foam during storage or handling to prevent electrostatic damage to the MOS gates.

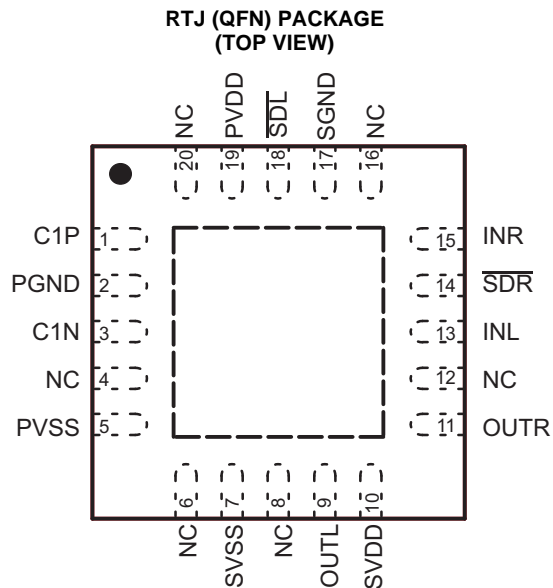

NC – No internal connection

**TERMINAL FUNCTIONS**

TERMINAL		I/O	DESCRIPTION
NAME	QFN		
C1P	1	I/O	Charge pump flying capacitor positive terminal
PGND	2	I	Power ground, connect to ground.
C1N	3	I/O	Charge pump flying capacitor negative terminal
NC	4, 6, 8, 12, 16, 20		No connection
PVSS	5	O	Output from charge pump.
SVSS	7	I	Amplifier negative supply, connect to PVSS via star connection.
OUTL	9	O	Left audio channel output signal
SVDD	10	I	Amplifier positive supply, connect to PVDD via star connection.
OUTR	11	O	Right audio channel output signal
INL	13	I	Left audio channel input signal
$\overline{\text{SDR}}$	14	I	Right channel shutdown, active low logic.
INR	15	I	Right audio channel input signal
SGND	17	I	Signal ground, connect to ground.
$\overline{\text{SDL}}$	18	I	Left channel shutdown, active low logic.
PVDD	19	I	Supply voltage, connect to positive supply.
Exposed Pad			Exposed pad must be soldered to a floating plane. Do NOT connect to power or ground.

## ABSOLUTE MAXIMUM RATINGS<sup>(1)</sup>

over operating free-air temperature range,  $T_A = 25^\circ\text{C}$  (unless otherwise noted)

		VALUE / UNIT
	Supply voltage, AVDD, PVDD	–0.3 V to 5.5 V
$V_I$	Input voltage	$V_{SS} - 0.3 \text{ V}$ to $V_{DD} + 0.3 \text{ V}$
$R_{(\text{Load})}$	Minimum load impedance	$\geq 100 \ \Omega$
$T_A$	Operating free-air temperature range	$0^\circ\text{C}$ to $70^\circ\text{C}$
$T_J$	Operating junction temperature range	$0^\circ\text{C}$ to $150^\circ\text{C}$
$T_{\text{stg}}$	Storage temperature range	$-65^\circ\text{C}$ to $85^\circ\text{C}$

- (1) Stresses beyond those listed under *absolute maximum ratings* may cause permanent damage to the device. These are stress ratings only, and functional operation of the device at these or any other conditions beyond those indicated under *recommended operating conditions* is not implied. Exposure to absolute-maximum-rated conditions for extended periods may affect device reliability.

## AVAILABLE OPTIONS

$T_A$	PACKAGED DEVICES <sup>(1)</sup>	PART NUMBER	SYMBOL
$0^\circ\text{C}$ to $70^\circ\text{C}$	20-pin, 4 mm x 4 mm QFN	DRV601RTJ <sup>(2)</sup>	AKQ

- (1) For the most current package and ordering information, see the Package Option Addendum at the end of this document, or see the TI website at [www.ti.com](http://www.ti.com).
- (2) The RTJ package is only available taped and reeled. To order, add the suffix "R" to the end of the part number for a reel of 3000, or add the suffix "T" to the end of the part number for a reel of 250 (e.g., DRV601RTJR).

## RECOMMENDED OPERATING CONDITIONS

		MIN	MAX	UNIT
$V_{SS}$	Supply voltage, AVDD, PVDD	1.8	4.5 <sup>(1)</sup>	V
$V_{IH}$	High-level input voltage	$\overline{SDL}$ , $\overline{SDR}$		V
$V_{IL}$	Low-level input voltage	$\overline{SDL}$ , $\overline{SDR}$	0.5	V
$T_A$	Operating free-air temperature	0	70	$^\circ\text{C}$

- (1) Device can shut down for  $V_{DD} > 4.5 \text{ V}$  to prevent damage to the device.

## ELECTRICAL CHARACTERISTICS

$T_A = 25^\circ\text{C}$  (unless otherwise noted)

PARAMETER	TEST CONDITIONS	MIN	TYP	MAX	UNIT
$ V_{OS} $	Output offset voltage			8	mV
PSRR	Power Supply Rejection Ratio		88		dB
$V_{OH}$	High-level output voltage	3.10			V
$V_{OL}$	Low-level output voltage			–3.05	V
$ I_{IH} $	High-level input current ( $\overline{SDL}$ , $\overline{SDR}$ )			1	$\mu\text{A}$
$ I_{IL} $	Low-level input current ( $\overline{SDL}$ , $\overline{SDR}$ )			1	$\mu\text{A}$
$I_{DD}$	Supply Current	$V_{DD} = 1.8 \text{ V}$ , No load, $\overline{SDL} = \overline{SDR} = V_{DD}$	5.3		mA
		$V_{DD} = 3.3 \text{ V}$ , No load, $\overline{SDL} = \overline{SDR} = V_{DD}$	7.1		
		$V_{DD} = 4.5 \text{ V}$ , No load, $\overline{SDL} = \overline{SDR} = V_{DD}$	8.7		
		Shutdown mode, $V_{DD} = 1.8 \text{ V}$ to $4.5 \text{ V}$		1	$\mu\text{A}$

## OPERATING CHARACTERISTICS

$V_{DD} = 3.3\text{ V}$ ,  $T_A = 25^\circ\text{C}$ ,  $R_L = 600\ \Omega$ ,  $C_{(PUMP)} = C_{(PVSS)} = 1\ \mu\text{F}$ ,  $C_{IN} = 1\ \mu\text{F}$ ,  $R_{in} = 10\ \text{k}\Omega$ ,  $R_{fb} = 20\ \text{k}\Omega$  (unless otherwise noted)

PARAMETER		TEST CONDITIONS	MIN	TYP	MAX	UNIT
$V_O$	Output Voltage(Outputs In Phase)	THD = 1%, $V_{DD} = 3.3\text{ V}$ , $f = 1\ \text{kHz}$		2.1		$V_{RMS}$
		THD = 1%, $V_{DD} = 4.5\text{ V}$ , $f = 1\ \text{kHz}$		2.7		
		THD = 1%, $V_{DD} = 4.5\text{ V}$ , $f = 1\ \text{kHz}$ , $R_L = 100\ \text{k}\Omega$		2.8		
THD+N	Total harmonic distortion plus noise	$V_O = 2\text{ Vrms}$ , $f = 1\ \text{kHz}$		0.008%		
		$V_O = 2\text{ Vrms}$ , $f = 6.67\ \text{kHz}$		0.030%		
	Crosstalk	$V_O = 2\text{ Vrms}$ , $f = 1\ \text{kHz}$		-80		dB
$A_{Vo}$	Open-loop voltage gain			155		dB
$R_{in}$	Input resistor range		1	10	47	k $\Omega$
$R_{fb}$	Feedback resistor range		4.7	20	100	k $\Omega$
	Slew rate			2.2		V/ $\mu\text{s}$
	Maximum capacitive load			300		pF
$V_n$	Noise output voltage	22-kHz filter, A-weighted		10		$\mu\text{Vrms}$
ESD	Electrostatic discharge	OUTR, OUTL		$\pm 8$		kV
$f_{osc}$	Charge pump switching frequency		280	320	420	kHz
	Start-up time from shutdown			450		$\mu\text{s}$
	Input impedance		1			M $\Omega$
SNR	Signal-to-noise ratio	$V_O = 2\text{ Vrms}$ (THD+N = 0.1%), 22-kHz BW, A-weighted		105		dB
$G_{(bw)}$	Unity Gain Bandwidth			3.5		MHz
	Thermal shutdown	Threshold	150		170	$^\circ\text{C}$
		Hysteresis		15		$^\circ\text{C}$

Functional Block Diagram

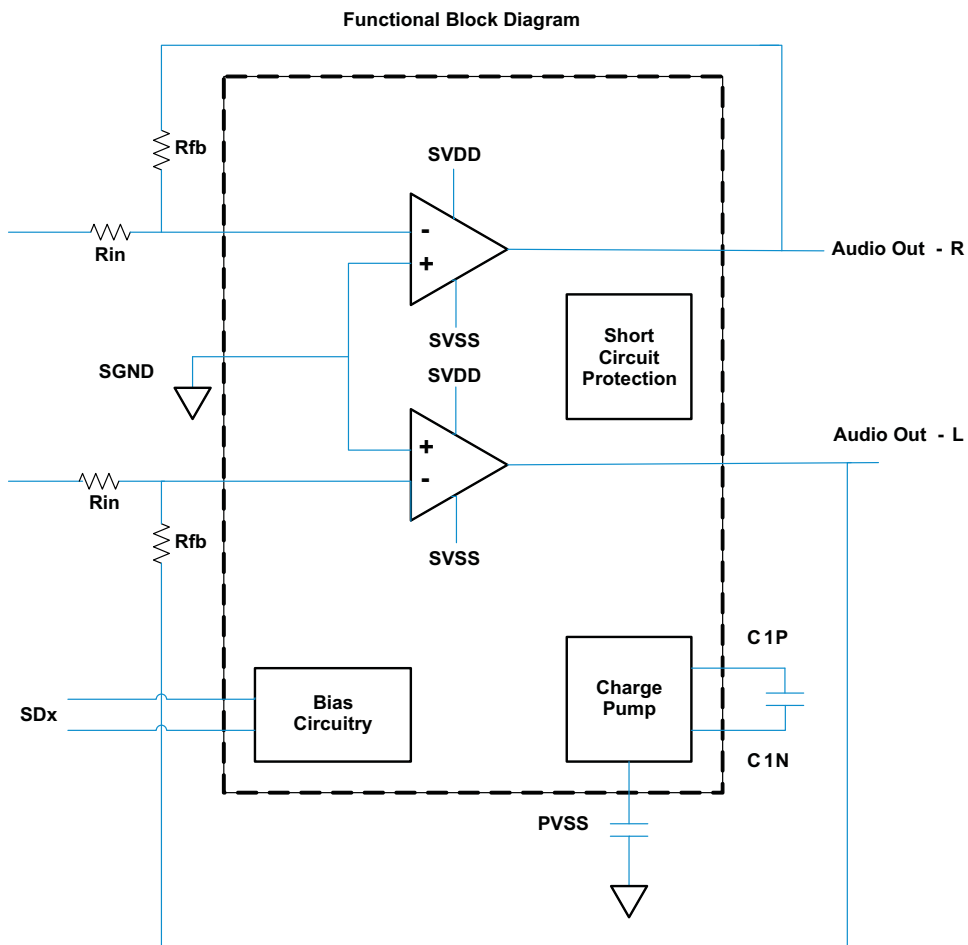

**TYPICAL CHARACTERISTICS**

$C_{(PUMP)} = C_{(PVSS)} = 1 \mu\text{F}$ ,  $C_{IN} = 1 \mu\text{F}$ ,  $R_{in} = 10 \text{ k}\Omega$ ,  $R_{fb} = 20 \text{ k}\Omega$  (unless otherwise noted)

**Table of Graphs**

		FIGURE
Total harmonic distortion + noise	vs Output Voltage	1-6
Total harmonic distortion + noise	vs Frequency	7-8
Quiescent supply current	vs Supply voltage	9
Output spectrum		10
Gain and phase	vs Frequency	11-12

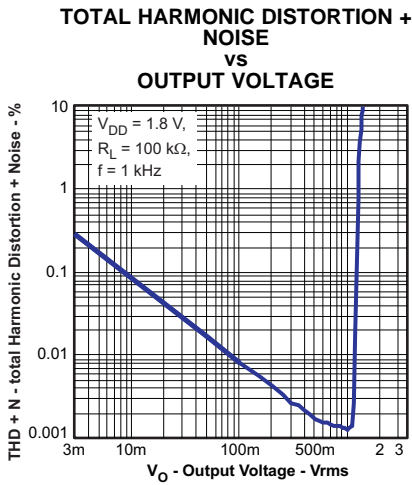

Figure 1.

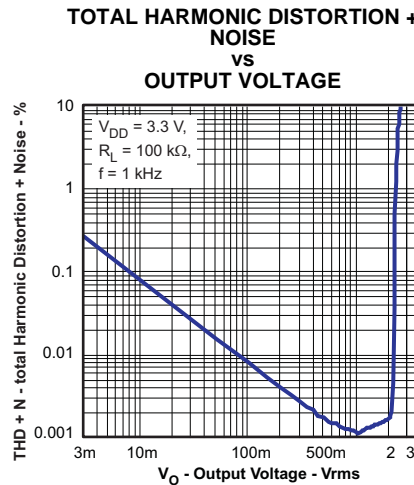

Figure 2.

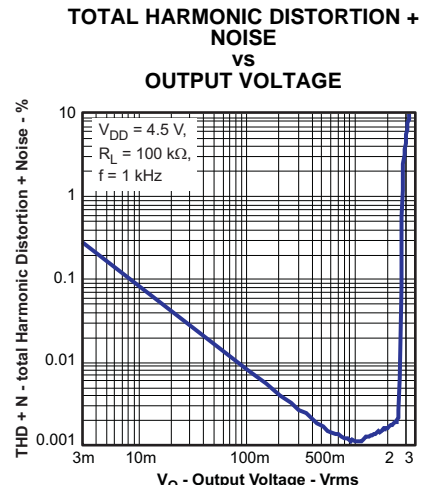

Figure 3.

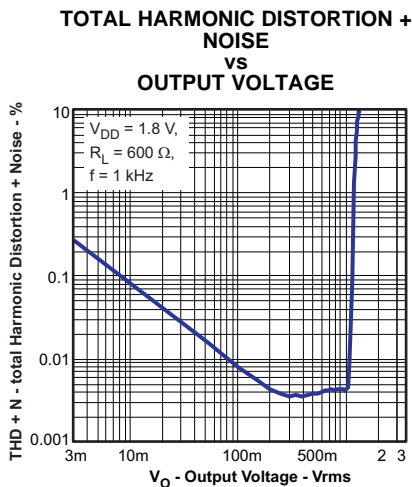

Figure 4.

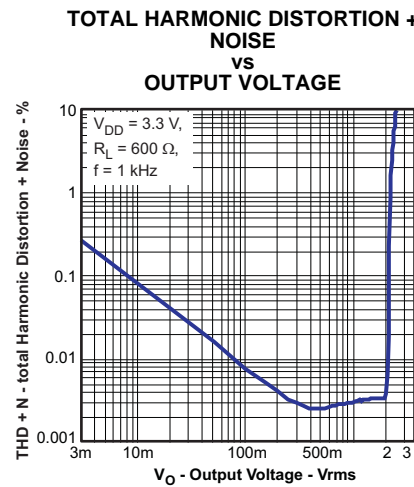

Figure 5.

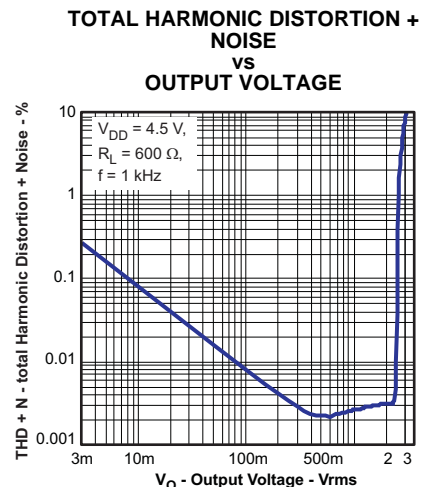

Figure 6.

**TOTAL HARMONIC DISTORTION + NOISE VS FREQUENCY**

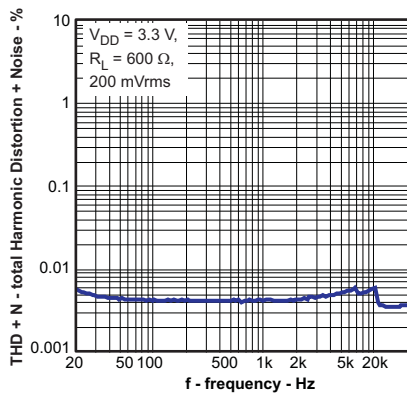

Figure 7.

**TOTAL HARMONIC DISTORTION + NOISE VS FREQUENCY**

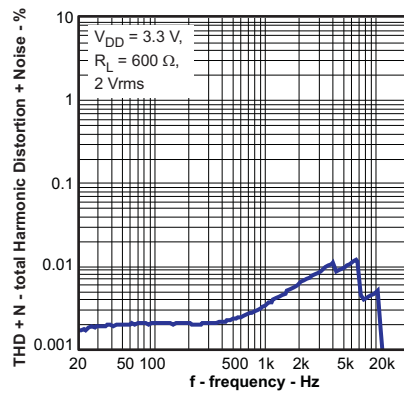

Figure 8.

**QUIESCENT SUPPLY CURRENT VS SUPPLY VOLTAGE**

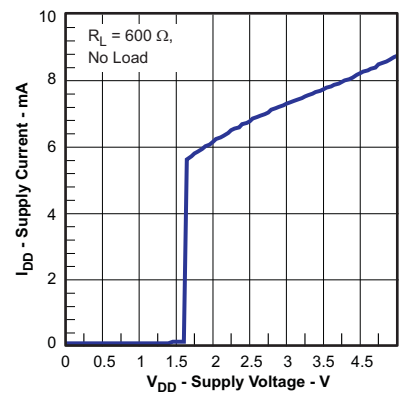

Figure 9.

**FFT VS FREQUENCY**

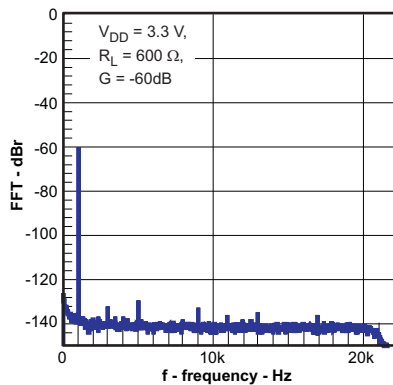

Figure 10.

**GAIN VS FREQUENCY**

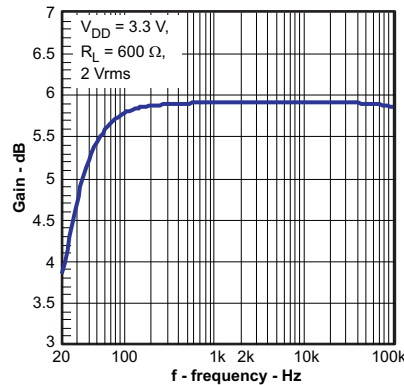

Figure 11.

**PHASE VS FREQUENCY**

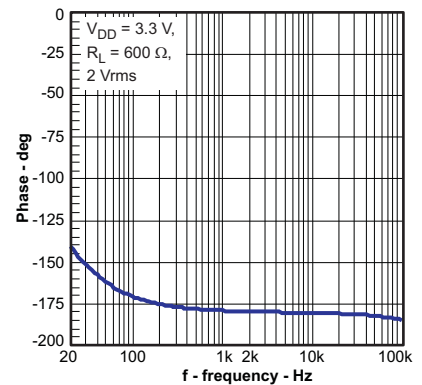

Figure 12.

## APPLICATION INFORMATION

### Line Driver Amplifiers

Single-supply Line Driver amplifiers typically require dc-blocking capacitors. The top drawing in [Figure 13](#) illustrates the conventional Line Driver amplifier connection to the load and output signal.

DC blocking capacitors are often large in value. The line load (typical resistive values of 600  $\Omega$  to 10 k $\Omega$ ) combine with the dc blocking capacitors to form a high-pass filter. [Equation 1](#) shows the relationship between the load impedance ( $R_L$ ), the capacitor ( $C_O$ ), and the cutoff frequency ( $f_c$ ).

$$f_c = \frac{1}{2\pi R_L C_O} \quad (1)$$

$C_O$  can be determined using [Equation 2](#), where the load impedance and the cutoff frequency are known.

$$C_O = \frac{1}{2\pi R_L f_c} \quad (2)$$

If  $f_c$  is low, the capacitor must then have a large value because the load resistance is small. Large capacitance values require large package sizes. Large package sizes consume PCB area, stand high above the PCB, increase cost of assembly, and can reduce the fidelity of the audio output signal.

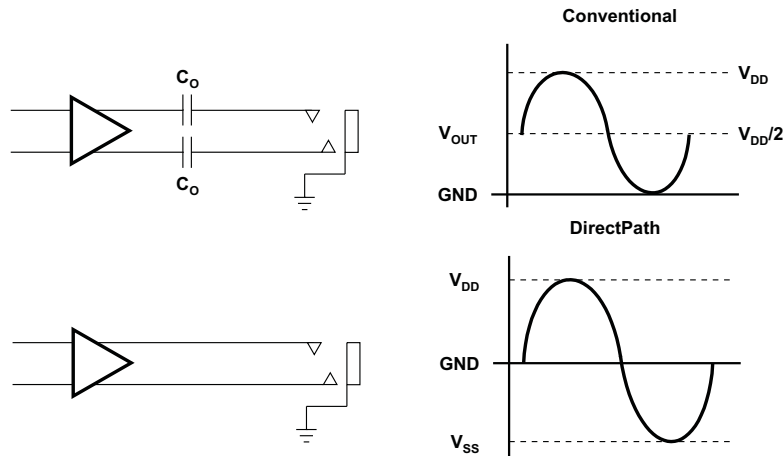

**Figure 13. Amplifier Applications**

The DirectPath™ amplifier architecture operates from a single supply but makes use of an internal charge pump to provide a negative voltage rail. Combining the user provided positive rail and the negative rail generated by the IC, the device operates in what is effectively a split supply mode. The output voltages are now centered at zero volts with the capability to swing to the positive rail or negative rail. The DirectPath™ amplifier requires no output dc blocking capacitors. The bottom block diagram and waveform of [Figure 13](#) illustrate the ground-referenced Line Driver architecture. This is the architecture of the DRV601.



## Charge Pump Flying Capacitor and PVSS Capacitor

The charge pump flying capacitor serves to transfer charge during the generation of the negative supply voltage. The PVSS capacitor must be at least equal to the charge pump capacitor in order to allow maximum charge transfer. Low ESR capacitors are an ideal selection, and a value of 1µF is typical. Capacitor values that are smaller than 1µF can be used, but the maximum output voltage may be reduced and the device may not operate to specifications.

## Decoupling Capacitors

The DRV601 is a DirectPath™ Line Driver amplifier that require adequate power supply decoupling to ensure that the noise and total harmonic distortion (THD) are low. A good low equivalent-series-resistance (ESR) ceramic capacitor, typically 2.2µF, placed as close as possible to the device V<sub>DD</sub> lead works best. Placing this decoupling capacitor close to the DRV601 is important for the performance of the amplifier. For filtering lower frequency noise signals, a 10-µF or greater capacitor placed near the audio power amplifier would also help, but it is not required in most applications because of the high PSRR of this device.

## Gain setting resistors ranges

The gain setting resistors, R<sub>in</sub> and R<sub>fb</sub>, must be chosen so that noise, stability and input capacitor size of the DRV601 is kept within acceptable limits. Voltage gain is defined as R<sub>fb</sub> divided by R<sub>in</sub>.

Selecting values that are too low demands a large input ac-coupling capacitor, C<sub>IN</sub>. Selecting values that are too high increases the noise of the amplifier. [Table 1](#) lists the recommended resistor values for different gain settings.

**Table 1. Recommended Resistor Values**

Gain	Input Resistor Value, R <sub>in</sub>	Feedback Resistor Value, R <sub>fb</sub>
-1 V/V	10 kΩ	10 kΩ
-1.5 V/V	10 kΩ	15 kΩ
-2 V/V	10 kΩ	20 kΩ
-10 V/V	4,7 kΩ	47 kΩ

## Input-Blocking Capacitors

DC input-blocking capacitors are required to be added in series with the audio signal into the input pins of the DRV601. These capacitors block the DC portion of the audio source and allow the DRV601 inputs to be properly biased to provide maximum performance.

These capacitors form a high-pass filter with the input resistor, R<sub>in</sub>. The cutoff frequency is calculated using [Equation 3](#). For this calculation, the capacitance used is the input-blocking capacitor and the resistance is the input resistor chosen from the gain table above, then the frequency and/or capacitance can be determined when one of the two values are given.

$$f_{C_{IN}} = \frac{1}{2\pi R_{IN} C_{IN}} \quad \text{or} \quad C_{IN} = \frac{1}{2\pi f_{C_{IN}} R_{IN}} \quad (3)$$

## Supply Voltage Limiting At 4.5 V

The DRV601 have a built-in charge pump which serves to generate a negative rail for the line driver. Because the line driver operates from a positive voltage and negative voltage supply, circuitry has been implemented to protect the devices in the amplifier from an overvoltage condition. Once the supply is above 4.5 V, the DRV601 can shut down in an overvoltage protection mode to prevent damage to the device. The DRV601 resume normal operation once the supply is reduced to 4.5 V or lower.

## Capacitive load

The DRV601 has the ability to drive a high capacitive load up to 330pF directly, higher capacitive loads can be accepted by adding a series resistor of 10Ω or larger. The figure below shows a 10kHz signal into a 470pF capacitor using the 10R series resistor.

**SQUARE WAVE OUTPUT VOLTAGE  
with  
CAPACITIVE LOAD**

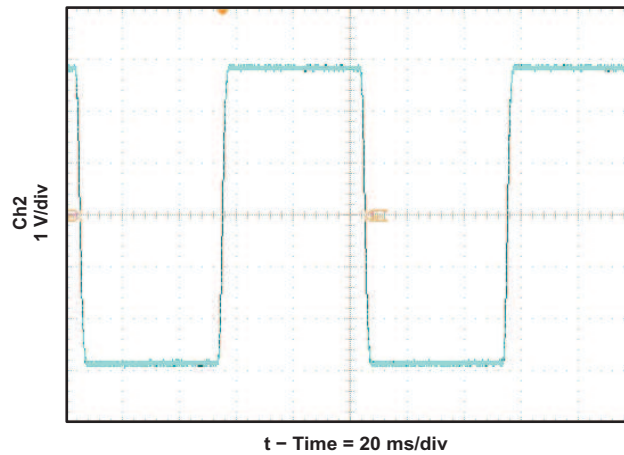

**Figure 14.**

### Layout Recommendations

A proposed layout for the DRV601 can be seen in the DRV601EVM user's guide, [SLOU215](#), and the Gerber files can be downloaded on [www.ti.com](http://www.ti.com), open the DRV601 product folder and look in the Tools & Software folder.

### Exposed Pad On DRV601RTJ Package

The exposed metal pad on the DRV601RTJ package must be soldered down to a pad on the PCB in order to maintain reliability. *The pad on the PCB should be allowed to float and not be connected to ground or power.* Connecting this pad to power or ground prevents the device from working properly because it is connected internally to PVSS.

### SGND and PGND Connections

The SGND and PGND pins of the DRV601 must be routed back to the decoupling capacitor separately in order to provide proper device operation. If the SGND and PGND pins are connected directly to each other, the part functions without risk of failure, but the noise and THD performance do not meet the specifications.

### Gain setting resistors

The gain setting resistors,  $R_{in}$  and  $R_{fb}$ , must be placed close to pin 13 respectively pin 17 to minimize the capacitive loading on these input pins and to ensure maximum stability of the DRV601. For the recommended PCB layout, see the DRV601EVM user guide.

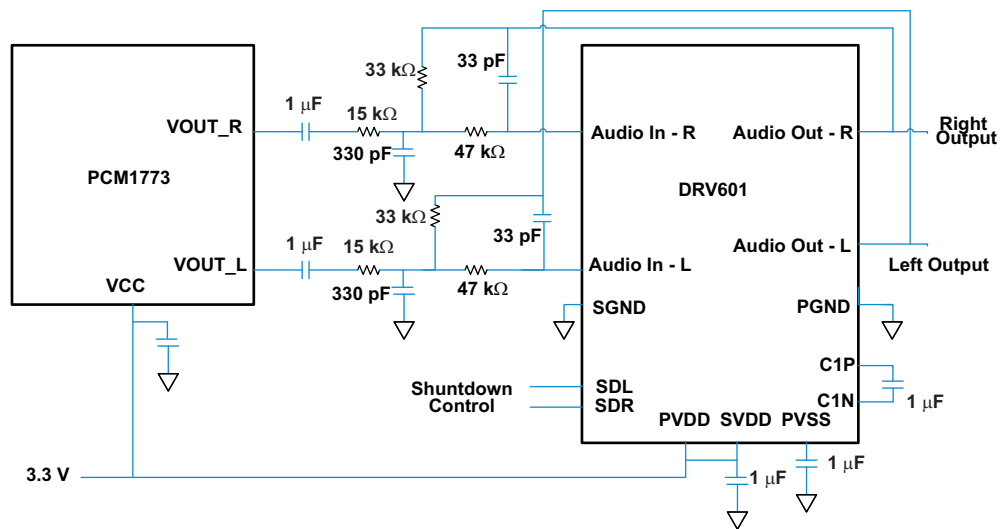

Figure 15. Application Circuit

**PACKAGING INFORMATION**

Orderable Device	Status <sup>(1)</sup>	Package Type	Package Drawing	Pins	Package Qty	Eco Plan <sup>(2)</sup>	Lead/Ball Finish	MSL Peak Temp <sup>(3)</sup>
DRV601RTJR	ACTIVE	QFN	RTJ	20	3000	Green (RoHS & no Sb/Br)	Cu NiPdAu	Level-2-260C-1 YEAR
DRV601RTJRG4	ACTIVE	QFN	RTJ	20	3000	Green (RoHS & no Sb/Br)	Cu NiPdAu	Level-2-260C-1 YEAR
DRV601RTJT	ACTIVE	QFN	RTJ	20	250	Green (RoHS & no Sb/Br)	Cu NiPdAu	Level-2-260C-1 YEAR
DRV601RTJTG4	ACTIVE	QFN	RTJ	20	250	Green (RoHS & no Sb/Br)	Cu NiPdAu	Level-2-260C-1 YEAR

<sup>(1)</sup> The marketing status values are defined as follows:

**ACTIVE:** Product device recommended for new designs.

**LIFEBUY:** TI has announced that the device will be discontinued, and a lifetime-buy period is in effect.

**NRND:** Not recommended for new designs. Device is in production to support existing customers, but TI does not recommend using this part in a new design.

**PREVIEW:** Device has been announced but is not in production. Samples may or may not be available.

**OBSOLETE:** TI has discontinued the production of the device.

<sup>(2)</sup> Eco Plan - The planned eco-friendly classification: Pb-Free (RoHS), Pb-Free (RoHS Exempt), or Green (RoHS & no Sb/Br) - please check <http://www.ti.com/productcontent> for the latest availability information and additional product content details.

**TBD:** The Pb-Free/Green conversion plan has not been defined.

**Pb-Free (RoHS):** TI's terms "Lead-Free" or "Pb-Free" mean semiconductor products that are compatible with the current RoHS requirements for all 6 substances, including the requirement that lead not exceed 0.1% by weight in homogeneous materials. Where designed to be soldered at high temperatures, TI Pb-Free products are suitable for use in specified lead-free processes.

**Pb-Free (RoHS Exempt):** This component has a RoHS exemption for either 1) lead-based flip-chip solder bumps used between the die and package, or 2) lead-based die adhesive used between the die and leadframe. The component is otherwise considered Pb-Free (RoHS compatible) as defined above.

**Green (RoHS & no Sb/Br):** TI defines "Green" to mean Pb-Free (RoHS compatible), and free of Bromine (Br) and Antimony (Sb) based flame retardants (Br or Sb do not exceed 0.1% by weight in homogeneous material)

<sup>(3)</sup> MSL, Peak Temp. -- The Moisture Sensitivity Level rating according to the JEDEC industry standard classifications, and peak solder temperature.

**Important Information and Disclaimer:**The information provided on this page represents TI's knowledge and belief as of the date that it is provided. TI bases its knowledge and belief on information provided by third parties, and makes no representation or warranty as to the accuracy of such information. Efforts are underway to better integrate information from third parties. TI has taken and continues to take reasonable steps to provide representative and accurate information but may not have conducted destructive testing or chemical analysis on incoming materials and chemicals. TI and TI suppliers consider certain information to be proprietary, and thus CAS numbers and other limited information may not be available for release.

In no event shall TI's liability arising out of such information exceed the total purchase price of the TI part(s) at issue in this document sold by TI to Customer on an annual basis.

**TAPE AND REEL INFORMATION**



**QUADRANT ASSIGNMENTS FOR PIN 1 ORIENTATION IN TAPE**



\*All dimensions are nominal

Device	Package Type	Package Drawing	Pins	SPQ	Reel Diameter (mm)	Reel Width W1 (mm)	A0 (mm)	B0 (mm)	K0 (mm)	P1 (mm)	W (mm)	Pin1 Quadrant
DRV601RTJT	QFN	RTJ	20	250	180.0	12.4	4.3	4.3	1.5	8.0	12.0	Q2

**TAPE AND REEL BOX DIMENSIONS**



\*All dimensions are nominal

Device	Package Type	Package Drawing	Pins	SPQ	Length (mm)	Width (mm)	Height (mm)
DRV601RTJT	QFN	RTJ	20	250	190.5	212.7	31.8

# MECHANICAL DATA

RTJ (S-PWQFN-N20)

PLASTIC QUAD FLATPACK NO-LEAD

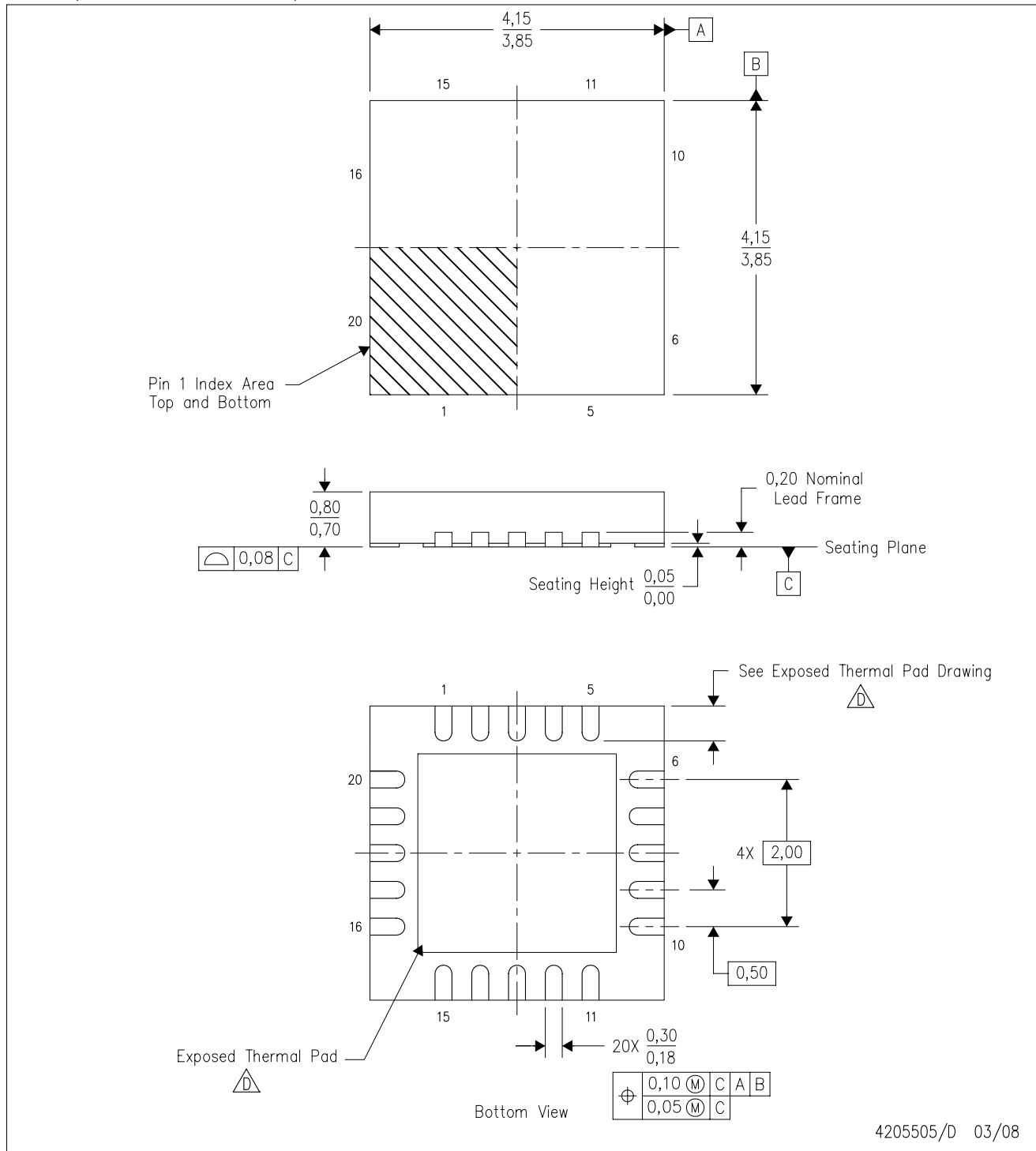

4205505/D 03/08

- NOTES:
- A. All linear dimensions are in millimeters. Dimensioning and tolerancing per ASME Y14.5-1994.
  - B. This drawing is subject to change without notice.
  - C. QFN (Quad Flatpack No-Lead) package configuration.
  -  The package thermal pad must be soldered to the board for thermal and mechanical performance. See the Product Data Sheet for details regarding the exposed thermal pad dimensions.

THERMAL INFORMATION

This package incorporates an exposed thermal pad that is designed to be attached directly to an external heatsink. The thermal pad must be soldered directly to the printed circuit board (PCB). After soldering, the PCB can be used as a heatsink. In addition, through the use of thermal vias, the thermal pad can be attached directly to the appropriate copper plane shown in the electrical schematic for the device, or alternatively, can be attached to a special heatsink structure designed into the PCB. This design optimizes the heat transfer from the integrated circuit (IC).

For information on the Quad Flatpack No-Lead (QFN) package and its advantages, refer to Application Report, Quad Flatpack No-Lead Logic Packages, Texas Instruments Literature No. SCBA017. This document is available at [www.ti.com](http://www.ti.com).

The exposed thermal pad dimensions for this package are shown in the following illustration.

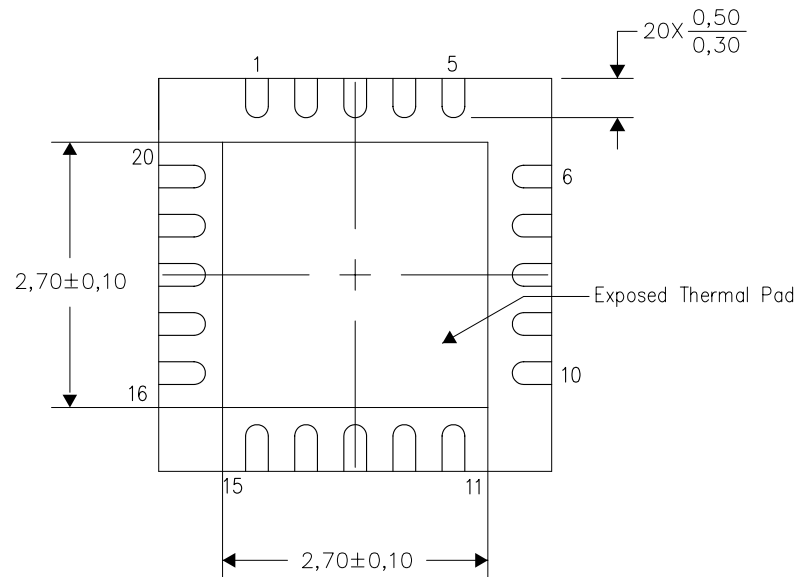

Bottom View

NOTE: All linear dimensions are in millimeters

Exposed Thermal Pad Dimensions



RTJ (S-PWQFN-N20)

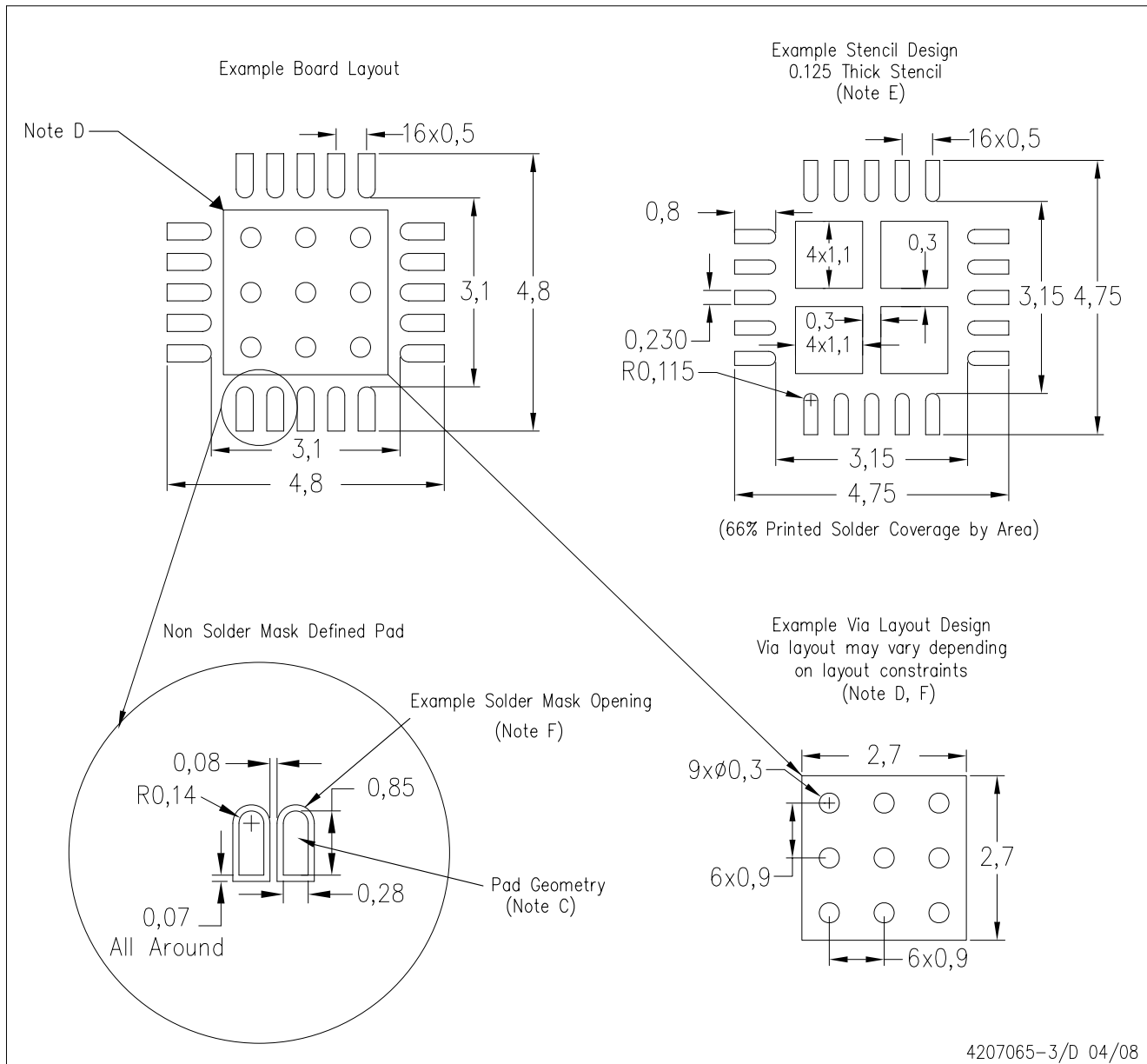

4207065-3/D 04/08

- NOTES:
- All linear dimensions are in millimeters.
  - This drawing is subject to change without notice.
  - Publication IPC-7351 is recommended for alternate designs.
  - This package is designed to be soldered to a thermal pad on the board. Refer to Application Note, Quad Flat-Pack Packages, Texas Instruments Literature No. SCBA017, SLUA271, and also the Product Data Sheets for specific thermal information, via requirements, and recommended board layout. These documents are available at [www.ti.com](http://www.ti.com) <<http://www.ti.com>>.
  - Laser cutting apertures with trapezoidal walls and also rounding corners will offer better paste release. Customers should contact their board assembly site for stencil design recommendations. Refer to IPC 7525 for stencil design considerations.
  - Customers should contact their board fabrication site for recommended solder mask tolerances and via tenting recommendations for vias placed in the thermal pad.

## IMPORTANT NOTICE

Texas Instruments Incorporated and its subsidiaries (TI) reserve the right to make corrections, modifications, enhancements, improvements, and other changes to its products and services at any time and to discontinue any product or service without notice. Customers should obtain the latest relevant information before placing orders and should verify that such information is current and complete. All products are sold subject to TI's terms and conditions of sale supplied at the time of order acknowledgment.

TI warrants performance of its hardware products to the specifications applicable at the time of sale in accordance with TI's standard warranty. Testing and other quality control techniques are used to the extent TI deems necessary to support this warranty. Except where mandated by government requirements, testing of all parameters of each product is not necessarily performed.

TI assumes no liability for applications assistance or customer product design. Customers are responsible for their products and applications using TI components. To minimize the risks associated with customer products and applications, customers should provide adequate design and operating safeguards.

TI does not warrant or represent that any license, either express or implied, is granted under any TI patent right, copyright, mask work right, or other TI intellectual property right relating to any combination, machine, or process in which TI products or services are used. Information published by TI regarding third-party products or services does not constitute a license from TI to use such products or services or a warranty or endorsement thereof. Use of such information may require a license from a third party under the patents or other intellectual property of the third party, or a license from TI under the patents or other intellectual property of TI.

Reproduction of TI information in TI data books or data sheets is permissible only if reproduction is without alteration and is accompanied by all associated warranties, conditions, limitations, and notices. Reproduction of this information with alteration is an unfair and deceptive business practice. TI is not responsible or liable for such altered documentation. Information of third parties may be subject to additional restrictions.

Resale of TI products or services with statements different from or beyond the parameters stated by TI for that product or service voids all express and any implied warranties for the associated TI product or service and is an unfair and deceptive business practice. TI is not responsible or liable for any such statements.

TI products are not authorized for use in safety-critical applications (such as life support) where a failure of the TI product would reasonably be expected to cause severe personal injury or death, unless officers of the parties have executed an agreement specifically governing such use. Buyers represent that they have all necessary expertise in the safety and regulatory ramifications of their applications, and acknowledge and agree that they are solely responsible for all legal, regulatory and safety-related requirements concerning their products and any use of TI products in such safety-critical applications, notwithstanding any applications-related information or support that may be provided by TI. Further, Buyers must fully indemnify TI and its representatives against any damages arising out of the use of TI products in such safety-critical applications.

TI products are neither designed nor intended for use in military/aerospace applications or environments unless the TI products are specifically designated by TI as military-grade or "enhanced plastic." Only products designated by TI as military-grade meet military specifications. Buyers acknowledge and agree that any such use of TI products which TI has not designated as military-grade is solely at the Buyer's risk, and that they are solely responsible for compliance with all legal and regulatory requirements in connection with such use.

TI products are neither designed nor intended for use in automotive applications or environments unless the specific TI products are designated by TI as compliant with ISO/TS 16949 requirements. Buyers acknowledge and agree that, if they use any non-designated products in automotive applications, TI will not be responsible for any failure to meet such requirements.

Following are URLs where you can obtain information on other Texas Instruments products and application solutions:

### Products

Amplifiers	<a href="http://amplifier.ti.com">amplifier.ti.com</a>
Data Converters	<a href="http://dataconverter.ti.com">dataconverter.ti.com</a>
DSP	<a href="http://dsp.ti.com">dsp.ti.com</a>
Clocks and Timers	<a href="http://www.ti.com/clocks">www.ti.com/clocks</a>
Interface	<a href="http://interface.ti.com">interface.ti.com</a>
Logic	<a href="http://logic.ti.com">logic.ti.com</a>
Power Mgmt	<a href="http://power.ti.com">power.ti.com</a>
Microcontrollers	<a href="http://microcontroller.ti.com">microcontroller.ti.com</a>
RFID	<a href="http://www.ti-rfid.com">www.ti-rfid.com</a>
RF/IF and ZigBee® Solutions	<a href="http://www.ti.com/lprf">www.ti.com/lprf</a>

### Applications

Audio	<a href="http://www.ti.com/audio">www.ti.com/audio</a>
Automotive	<a href="http://www.ti.com/automotive">www.ti.com/automotive</a>
Broadband	<a href="http://www.ti.com/broadband">www.ti.com/broadband</a>
Digital Control	<a href="http://www.ti.com/digitalcontrol">www.ti.com/digitalcontrol</a>
Medical	<a href="http://www.ti.com/medical">www.ti.com/medical</a>
Military	<a href="http://www.ti.com/military">www.ti.com/military</a>
Optical Networking	<a href="http://www.ti.com/opticalnetwork">www.ti.com/opticalnetwork</a>
Security	<a href="http://www.ti.com/security">www.ti.com/security</a>
Telephony	<a href="http://www.ti.com/telephony">www.ti.com/telephony</a>
Video & Imaging	<a href="http://www.ti.com/video">www.ti.com/video</a>
Wireless	<a href="http://www.ti.com/wireless">www.ti.com/wireless</a>

Mailing Address: Texas Instruments, Post Office Box 655303, Dallas, Texas 75265  
Copyright © 2008, Texas Instruments Incorporated