



# Single-Supply, Auto-Zero Sensor Amplifier with Programmable Gain and Offset

## FEATURES

- Digital Calibration for Bridge Sensors
- Offset Select: Coarse and Fine
- Gain Select: Coarse and Fine
- Bridge Fault Monitor
- Input Mux for Lead Swap
- Over/Under Scale Limits
- $D_{OUT}/V_{OUT}$  Clamp Function
- Seven Banks OTP Memory
- One-Wire Digital UART Interface
- Operating Voltage: +2.7V to +5.5V
- Temperature Range:  $-40^{\circ}\text{C}$  to  $+125^{\circ}\text{C}$
- MSOP-10 and 3mm x 4mm DFN-10 Packages

## APPLICATIONS

- Bridge Sensors
- Remote 4-20mA Transmitters
- Strain, Load, Weigh Scales
- Automotive Sensors

## EVALUATION TOOLS

- PGA308EVM (Hardware and Software)
  - Calibration and Configuration
  - Sensor Emulation

## DESCRIPTION

The PGA308 is a programmable analog sensor signal conditioner. The analog signal path amplifies the sensor signal and provides digital calibration for offset and gain. Calibration is done via the 1W pin, a digital One-Wire, UART-compatible interface. For three-terminal sensor modules, 1W may be connected to  $V_{OUT}$  and the assembly programmed through the  $V_{OUT}$  pin. Gain and offset calibration parameters are stored onboard in seven banks of one-time programmable (OTP) memory. The power-on reset (POR) OTP bank may be programmed a total of four times.

The all-analog signal path contains a 2x2 input multiplexer (mux) to allow electronic sensor lead swapping, a coarse offset adjust, an auto-zero programmable gain instrumentation amplifier (PGA), a fine gain adjust, a fine offset adjust, and a programmable gain output amplifier. Fault monitor circuitry detects and signals sensor burnout, overload, and system fault conditions. Over/under-scale limits provide additional means for system level diagnostics. The dual-use  $D_{OUT}/V_{CLAMP}$  pin can be used as a programmable digital output or as a  $V_{OUT}$  over-voltage clamp.

For detailed application information, see the [PGA308 User's Guide \(SBOU069\)](#) available for download at [www.ti.com](#).

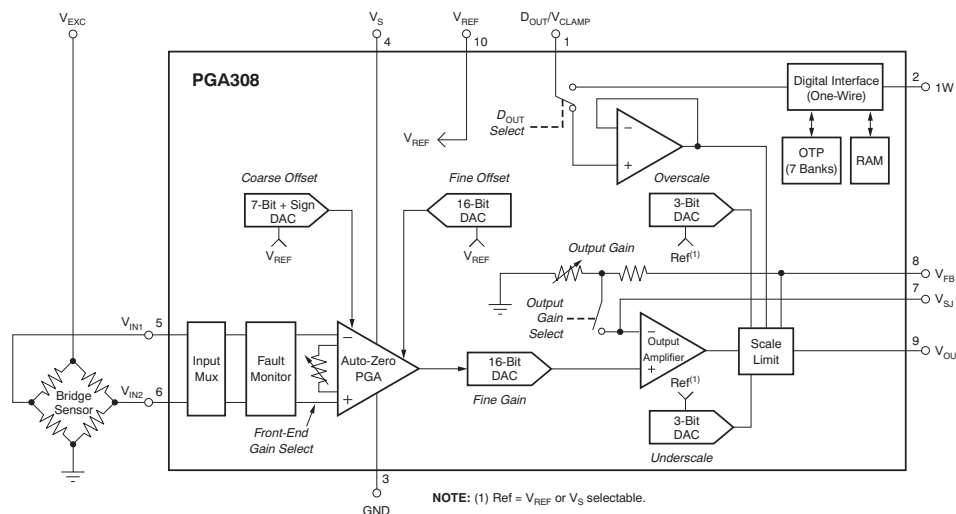

Please be aware that an important notice concerning availability, standard warranty, and use in critical applications of Texas Instruments semiconductor products and disclaimers thereto appears at the end of this data sheet.

All trademarks are the property of their respective owners.



This integrated circuit can be damaged by ESD. Texas Instruments recommends that all integrated circuits be handled with appropriate precautions. Failure to observe proper handling and installation procedures can cause damage.

ESD damage can range from subtle performance degradation to complete device failure. Precision integrated circuits may be more susceptible to damage because very small parametric changes could cause the device not to meet its published specifications.

### PACKAGE/ORDERING INFORMATION<sup>(1)</sup>

PRODUCT	PACKAGE-LEAD	PACKAGE DESIGNATOR	PACKAGE MARKING
PGA308	MSOP-10	DGS	P30A
	3mm x 4mm DFN-10 <sup>(2)</sup>	DRK	P30B

(1) For the most current package and ordering information see the Package Option Addendum at the end of this document, or see the TI web site at [www.ti.com](http://www.ti.com).

(2) Available Q1, 2009.

### ABSOLUTE MAXIMUM RATINGS<sup>(1)</sup>

Over operating free-air temperature range, unless otherwise noted.

PARAMETER		PGA308	UNIT
Supply Voltage, $V_S$		+5.5	V
$D_{OUT}/V_{CLAMP}$ Output Current Limit		$\pm 10$	mA
Pin Protection	Input Current	-10 to +10	mA
	$V_{IN1}, V_{IN2}, V_{REF}, 1W, D_{OUT}/V_{CLAMP}, V_{SJ}$ <sup>(2)</sup>	GND – 0.3 to $V_S + 0.3$	V
	$V_{FB}$ Terminal Voltage	-30 to 30	V
	$V_{FB}$ Terminal Current	-10 to 10	mA
$V_{OUT}$		-160 to 160	mA
Operating Temperature Range		-40 to +150	°C
Storage Temperature Range		-55 to +150	°C
Junction Temperature		+165	°C
ESD Ratings	Human Body Model (HBM)	2000	V

(1) Stresses above these ratings may cause permanent damage. Exposure to absolute maximum conditions for extended periods may degrade device reliability. These are stress ratings only, and functional operation of the device at these or any other conditions beyond those specified is not implied.

(2) Terminals are diode-clamped to the power-supply rails,  $V_S$  and GND. Limit current to 10mA or less.

## ELECTRICAL CHARACTERISTICS

**Boldface** limits apply over the specified temperature range,  $T_A = -40^{\circ}\text{C}$  to  $+125^{\circ}\text{C}$ .

At  $T_A = +25^{\circ}\text{C}$ ,  $V_S = +5\text{V}$ ,  $\text{GND} = 0\text{V}$ ,  $D_{\text{OUT}}/V_{\text{CLAMP}} = +5\text{V}$ , and  $V_{\text{REF}} = +5\text{V}$ , unless otherwise noted.

PARAMETER	CONDITIONS	PGA308			UNIT
		MIN	TYP	MAX	
$V_{\text{OUT}}/V_{\text{IN}}$ Differential Signal Gains <sup>(1)</sup> (Front-End PGA + Output Amplifier)	Front-End PGA gains ( $G_F$ ): 4, 6, 8, 12, 16, 32, 64, 100, 200, 400, 480, 600, 800, 960, 1200, 1600 Output Amplifier gains: 2, 2.4, 3, 3.6, 4, 4.5, 6 Fine Gain Adjust = 0.33 to 1	2.67		9600	V/V
$V_{\text{OUT}}/V_{\text{IN}}$ Slew Rate (Front End PGA + Output Amplifier)	CMP_SEL [CFG1 register] = 0		0.6		V/ $\mu\text{s}$
	CMP_SEL [CFG1 register] = 1		0.3		V/ $\mu\text{s}$
$V_{\text{OUT}}/V_{\text{IN}}$ Settling Time (0.01%FSR) (Front-End PGA + Output Amplifier)	$V_{\text{OUT}}/V_{\text{IN}}$ differential gain = 8, $V_{\text{OUT}} = +0.5\text{V}$ to $+4.5\text{V}$ step, comp off, no capacitive load		13		$\mu\text{s}$
	$V_{\text{OUT}}/V_{\text{IN}}$ differential gain = 200, $V_{\text{OUT}} = +0.5\text{V}$ to $+4.5\text{V}$ step, comp off, no capacitive load		15		$\mu\text{s}$
External Sensor Output Sensitivity <sup>(2)</sup>	$V_S = V_{\text{REF}} = V_{\text{CLAMP}} = +5\text{V}$	0.08		296	mV/V
<b>FRONT-END PGA</b>					
Auto-Zero Internal Frequency			40		kHz
Offset Voltage (RTI) <sup>(3)</sup> <b>vs Temperature</b> vs Supply Voltage, $V_S$ vs Common-Mode Voltage	Coarse Offset Adjust disabled		$\pm 5$	$\pm 40$	$\mu\text{V}$
	<b>Coarse Offset Adjust disabled</b>		<b><math>\pm 0.2</math></b>		<b><math>\mu\text{V}/^{\circ}\text{C}</math></b>
	Coarse Offset Adjust disabled		$2 + 150/G_F$	$10 + 1000/G_F$	$\mu\text{V}/\text{V}$
	$G_F = \text{Front-End PGA gain, Coarse Offset Adjust disabled}$		$1 + 250/G_F$	$10 + 2000/G_F$	$\mu\text{V}/\text{V}$
Offset Voltage Programming Range (RTI) <sup>(3)</sup> <b>vs Temperature</b> vs Supply Voltage, $V_S$ vs Common-Mode Voltage	Coarse Offset Adjust enabled, Coarse Offset Adjust controls offset	-100		100	mV
	<b>Coarse Offset Adjust enabled</b>		<b><math>\pm 0.2</math></b>		<b><math>\mu\text{V}/^{\circ}\text{C}</math></b>
	Coarse Offset Adjust enabled		$2 + 150/G_F$		$\mu\text{V}/\text{V}$
	$G_F = \text{Front End PGA gain, Coarse Offset Adjust enabled}$		$1 + 250/G_F$		$\mu\text{V}/\text{V}$
Linear Input Voltage Range <sup>(4)</sup>		0.2		$V_S - 1.4$	V
Input Bias Current <b>vs Temperature</b>			$\pm 0.3$	$\pm 1.5$	nA
			<b>10</b>		<b><math>\text{pA}/^{\circ}\text{C}</math></b>
Input Offset Current <b>vs Temperature</b>			$\pm 0.1$	$\pm 1.5$	nA
			<b>10</b>		<b><math>\text{pA}/^{\circ}\text{C}</math></b>
Input Impedance: Differential			30    6		$\text{G}\Omega$    pF
Input Impedance: Common Mode			50    20		$\text{G}\Omega$    pF
Input Voltage Noise	RTI, dc to 10Hz, $G_F = 100$ , $R_S = 0\Omega$		1.2		$\mu\text{V}_{\text{PP}}$
Input Voltage Noise Density	RTI, voltage noise density, $f = 1\text{kHz}$ , Coarse Offset Adjust = 0V		50		$\text{nV}/\sqrt{\text{Hz}}$
	RTI, voltage noise density, $f = 1\text{kHz}$ , Coarse Offset Adjust = 100mV		80		$\text{nV}/\sqrt{\text{Hz}}$
Input EMI Filter Frequency	$f_{3\text{dB}}$ Input EMI filter to GND, $V_{\text{IN}1}$ and $V_{\text{IN}2}$		40		MHz
<b>PGA Gain<sup>(5)</sup></b>					
Gain Range Steps	4, 6, 8, 12, 16, 32, 64, 100, 200, 400, 480, 600, 800, 960, 1200, 1600	4		1600	V/V
Initial Gain Error	$G_F \leq 16$		$\pm 0.03$	$\pm 0.25$	%
	$32 \leq G_F \leq 480$		$\pm 0.1$	$\pm 0.4$	%
	$600 \leq G_F \leq 1600$		$\pm 0.3$	$\pm 1$	%
<b>vs Temperature</b>			<b>6</b>		<b><math>\text{ppm}/^{\circ}\text{C}</math></b>
Output Voltage Range		0.05		$V_S - 0.05$	V
Bandwidth	$G_F = 4$		400		kHz
	$G_F = 1600$		10		kHz

- (1) PGA308 total differential gain from input ( $V_{\text{IN}1} - V_{\text{IN}2}$ ) to output ( $V_{\text{OUT}}$ ):  $V_{\text{OUT}} / (V_{\text{IN}1} - V_{\text{IN}2}) = (\text{PGA gain}) \times (\text{output amplifier gain}) \times (\text{fine gain adjust})$  with output amplifier internal gains used.
- (2) Based on bridge sensor excitation voltage of +5V and PGA308 output voltage span of 4V. Individual applications must consider noise, small-signal bandwidth, and required system error to assess if the PGA308 will work for a given sensor sensitivity.
- (3) RTI = Referred-to-input.
- (4) Linear input range is the allowed min/max voltage on the  $V_{\text{IN}1}$  and  $V_{\text{IN}2}$  pins for the front-end PGA to continue to operate in a linear region. The allowed common-mode and differential voltage depends on gain and offset settings. Refer to the [PGA308 User's Guide \(SBOU069\)](#), for more information.
- (5)  $I_{\text{REF}}$  current load is typically 100 $\mu\text{A}$  while in Shutdown mode. Although the output amplifier is disabled in Shutdown mode, RFO and RGO (180k $\Omega$  typical total) remain connected in series between  $V_{\text{FB}}$  and GND while in Shutdown mode. See [Figure 37, Detailed Block Diagram](#), for more information.

## ELECTRICAL CHARACTERISTICS (continued)

**Boldface** limits apply over the specified temperature range,  $T_A = -40^{\circ}\text{C}$  to  $+125^{\circ}\text{C}$ .

At  $T_A = +25^{\circ}\text{C}$ ,  $V_S = +5\text{V}$ ,  $\text{GND} = 0\text{V}$ ,  $D_{\text{OUT}}/V_{\text{CLAMP}} = +5\text{V}$ , and  $V_{\text{REF}} = +5\text{V}$ , unless otherwise noted.

PARAMETER	CONDITIONS	PGA308			UNIT
		MIN	TYP	MAX	
<b>Coarse Offset Adjust (RTI of Front-End PGA)<sup>(6)</sup></b>					
Range	$V_{\text{REF}} = +5\text{V}$	-100		+100	mV
Resolution	7 bit + sign, $V_{\text{REF}} = +5\text{V}$		1		mV
PSRR			2		$\mu\text{V}/\text{V}$
CMRR			1		$\mu\text{V}/\text{V}$
<b>Drift</b>	<b>Coarse Offset Adjust = 100mV</b>		<b>1.2</b>		$\mu\text{V}/^{\circ}\text{C}$
<b>Fine Offset Adjust (Zero DAC)</b>					
Programming Range	RTO of Front-End PGA	$-0.5V_{\text{REF}}$		$+0.5V_{\text{REF}}$	V
Output Voltage Range		0.1		$V_S - 0.1$	V
Resolution	65,536 steps, 16-bit DAC, $V_{\text{REF}} = +5\text{V}$		76		$\mu\text{V}$
Integral Nonlinearity			$\pm 6$		LSB
Differential Nonlinearity			$\pm 0.5$		LSB
Gain Error			$\pm 0.5$		%
<b>Gain Error Drift</b>			<b><math>\pm 4</math></b>		<b>ppm/<math>^{\circ}\text{C}</math></b>
Offset			$\pm 4$		mV
<b>Offset Drift</b>			<b><math>\pm 10</math></b>		<b><math>\mu\text{V}/^{\circ}\text{C}</math></b>
PSRR			$\pm 200$		$\mu\text{V}/\text{V}$
<b>Output Amplifier</b>					
<b>Output Fine Gain Adjust (Gain DAC)</b>					
Range		0.33		1	V/V
Resolution	65,536 steps, 16-bit DAC		10		$\mu\text{V}/\text{V}$
Integral Nonlinearity			$\pm 6$		LSB
Differential Nonlinearity			$\pm 0.5$		LSB
Gain Error				$\pm 0.2$	%
<b>Gain Drift</b>			<b>3</b>		<b>ppm/<math>^{\circ}\text{C}</math></b>
<b>Output Amplifier</b>					
Offset Voltage (RTI of Output Amplifier) <sup>(6)</sup>			$\pm 3$		mV
<b>vs Temperature</b>			<b><math>\pm 5</math></b>		<b><math>\mu\text{V}/^{\circ}\text{C}</math></b>
vs Supply Voltage, $V_S$			$\pm 100$		$\mu\text{V}/\text{V}$
Common Mode Input Range		0		$V_S - 1.5$	V
Input Bias Current			$\pm 100$		pA
Amplifier Internal Gain					
Gain Range Steps	2, 2.4, 3, 3.6, 4, 4.5, 6	2		6	V/V
Initial Gain Error			$\pm 0.05$	$\pm 0.25$	%
<b>vs Temperature</b>			<b><math>\pm 1</math></b>		<b>ppm/<math>^{\circ}\text{C}</math></b>
Output Voltage Range	$I_{\text{OUT}} = 0.5\text{mA}^{(7)}$	0.03		$V_S - 0.06$	V
	$I_{\text{OUT}} = 4\text{mA}^{(7)}$	0.1		$V_S - 0.1$	V
Output Short Circuit Current	$I_{\text{SC}}$ Sourcing/sinking	10			mA
OpenLoop Gain at 0.1Hz			106		dB
Gain-Bandwidth Product			2		MHz
Phase Margin	Gain = 2, $C_L = 200\text{pF}$		45		deg
Output Resistance	$R_O$ AC small signal, open loop, $f = 1\text{MHz}$ , $I_{\text{OUT}} = 0$ , see Figure 28		500		$\Omega$

(6) RTI = Referred-to-input.

(7) Unless limited by the over/under-scale setting, or  $V_{\text{CLAMP}}$  Pin.

**ELECTRICAL CHARACTERISTICS (continued)**
**Boldface** limits apply over the specified temperature range,  $T_A = -40^{\circ}\text{C}$  to  $+125^{\circ}\text{C}$ .

 At  $T_A = +25^{\circ}\text{C}$ ,  $V_S = +5\text{V}$ ,  $\text{GND} = 0\text{V}$ ,  $D_{\text{OUT}}/V_{\text{CLAMP}} = +5\text{V}$ , and  $V_{\text{REF}} = +5\text{V}$ , unless otherwise noted.

PARAMETER	CONDITIONS	PGA308			UNIT	
		MIN	TYP	MAX		
<b>Over- and Under-Scale Limits</b>						
Over-Scale Thresholds						
	$V_{\text{LIM}} = 4\text{V}$ , register-selectable ratio of $V_{\text{LIM}}$					
OS0	HL[2:0] (CFG1 register D[5:3]) = 000	0.97	0.9805	0.99	V/V	
OS1	HL[2:0] (CFG1 register D[5:3]) = 001	0.9588	0.9688	0.9788	V/V	
OS2	HL[2:0] (CFG1 register D[5:3]) = 010	0.9509	0.9609	0.9709	V/V	
OS3	HL[2:0] (CFG1 register D[5:3]) = 011	0.9392	0.9492	0.9492	V/V	
OS4	HL[2:0] (CFG1 register D[5:3]) = 100	0.8416	0.8516	0.8616	V/V	
OS5	HL[2:0] (CFG1 register D[5:3]) = 101	0.7673	0.7773	0.7873	V/V	
OS6	HL[2:0] (CFG1 register D[5:3]) = 110	0.6189	0.6289	0.6389	V/V	
OS7	HL[2:0] (CFG1 register D[5:3]) = 111	0.5603	0.5703	0.5803	V/V	
<b>Over-Scale Threshold Tempco</b>			<b>±3</b>		<b>ppm/°C</b>	
Over-Scale Amplifier Offset			±9		mV	
<b>Over-Scale Amplifier Offset Drift</b>			<b>±10</b>		<b>µV/°C</b>	
Under-Scale Thresholds						
	$V_{\text{LIM}} = 5\text{V}$ , register-selectable ratio of $V_{\text{LIM}}$					
US7	LL[2:0] (CFG1 register D[2:0]) = 111	0.0487	0.0547	0.0607	V/V	
US6	LL[2:0] (CFG1 register D[2:0]) = 110	0.04478	0.05078	0.05678	V/V	
US5	LL[2:0] (CFG1 register D[2:0]) = 101	0.04088	0.04688	0.05288	V/V	
US4	LL[2:0] (CFG1 register D[2:0]) = 100	0.03306	0.03906	0.04506	V/V	
US3	LL[2:0] (CFG1 register D[2:0]) = 011	0.02916	0.03516	0.04116	V/V	
US2	LL[2:0] (CFG1 register D[2:0]) = 010	0.02525	0.03125	0.03725	V/V	
US1	LL[2:0] (CFG1 register D[2:0]) = 001	0.01743	0.02343	0.02943	V/V	
US0	LL[2:0] (CFG1 register D[2:0]) = 000	0.01353	0.01953	0.02553	V/V	
<b>Under-Scale Threshold Tempco</b>			<b>±3</b>		<b>ppm/°C</b>	
Under-Scale Amplifier Offset			±9		mV	
<b>Under-Scale Amplifier Offset Drift</b>			<b>±10</b>		<b>µV/°C</b>	
<b>Output Voltage Clamp</b>						
Input Voltage Range		$V_{\text{CLAMP}} \leq V_S$ , $V_S = +5\text{V}$	1.25		4.95	V
Input Bias Current				±60		nA
$V_{\text{OUT}}$ Clamp Point			$V_{\text{CLAMP}} - 0.05$	$V_{\text{CLAMP}}$	$V_{\text{CLAMP}} + 0.05$	V
<b>Fault Monitor Circuit (External Comparators)</b>						
INP_HI Comparator Threshold INN_HI Comparator Threshold		Fault Detect Mode Select = 0 (bridge fault); see CFG1 register	Smaller of $(V_S - 1.2)$ or $(0.65V_{\text{FLT}})$			V
INP_LO Comparator Threshold INN_LO Comparator Threshold		Fault Detect Mode Select = 0 (bridge fault); see CFG1 register	Larger of $(0.1\text{V})$ or $(0.35V_{\text{FLT}})$			V
Fault Monitor Reference		$V_{\text{FLT}}$ Fault Monitor Reference; see CFG1 register, FLT REF bit sets $V_{\text{FLT}}$		$V_S$ or $V_{\text{REF}}$		V
INP_HI Comparator Threshold INN_HI Comparator Threshold		Fault Detect Mode Select = 1 (common mode fault); see CFG1 register		$V_S - 1.2$		V
INP_LO Comparator Threshold INN_LO Comparator Threshold		Fault Detect Mode Select = 1 (common mode fault); see CFG1 register	70	100	130	mV
Comparator Hysteresis				7		mV
Comparator Input Offset Voltage				±10		mV
<b>Fault Monitor Circuit (Internal Comparators)</b>						
A1SAT_LO Comparator Threshold A2SAT_LO Comparator Threshold		Threshold is amplifier negative saturation voltage		100		mV
A1SAT_HI Comparator Threshold A2SAT_HI Comparator Threshold		Threshold is amplifier positive saturation voltage		$V_S - 0.12$		V
A3SAT_LO Comparator Threshold		Threshold is amplifier negative saturation voltage		50		mV
<b><math>V_{\text{IN1}}</math>, <math>V_{\text{IN2}}</math> Pull-up Current Sources</b>						
Pull-Up Current Source		$I_{\text{PU}}$ Register-selectable	15	30	45	nA
Current Source Matching				±1.5	±7	nA
<b>Current Source Tempco</b>				<b>±5</b>		<b>pA/°C</b>

## ELECTRICAL CHARACTERISTICS (continued)

**Boldface** limits apply over the specified temperature range,  $T_A = -40^{\circ}\text{C}$  to  $+125^{\circ}\text{C}$ .

At  $T_A = +25^{\circ}\text{C}$ ,  $V_S = +5\text{V}$ ,  $\text{GND} = 0\text{V}$ ,  $D_{\text{OUT}}/V_{\text{CLAMP}} = +5\text{V}$ , and  $V_{\text{REF}} = +5\text{V}$ , unless otherwise noted.

PARAMETER	CONDITIONS	PGA308			UNIT
		MIN	TYP	MAX	
$V_{\text{REF}}$					
Input Range		1.8		$V_S$	V
Input Resistance			43		k $\Omega$
<b>Digital Interface</b>					
One-Wire	Serial speed baud rate	4.8k		114k	bits/s
<b>Logic Levels</b>					
Logic Levels (1W pin)	Low			0.8	V
	High	2.0			V
	Hysteresis		100		mV
Output Low Level (1W pin)	Open drain, $I_{\text{SINK}} = 4\text{mA}$			0.4	V
Output Levels ( $D_{\text{OUT}}/V_{\text{CLAMP}}$ )	Low, $D_{\text{OUT}}$ mode selected, $I_{\text{SINK}} = 4\text{mA}$ and $V_S = +4.5\text{V}$ , or $I_{\text{SINK}} = 2\text{mA}$ and $V_S = +2.7\text{V}$			0.4	V
	High, $D_{\text{OUT}}$ mode selected, $I_{\text{SOURCE}} = 4\text{mA}$ and $V_S = +4.5\text{V}$ , or $I_{\text{SOURCE}} = 2\text{mA}$ and $V_S = +2.7\text{V}$	$V_S - 0.4$			V
<b>POWER SUPPLY</b>					
Supply Voltage	$V_S$	2.7		5.5	V
OTP Program Votage	$V_{\text{S-PGM}}$	4.5		5.5	V
Quiescent Current	$I_Q$		1.3	1.6	mA
Shutdown Supply Current	$I_{\text{SHDN}}$		260		$\mu\text{A}$
<b>POWER-ON RESET (POR)</b>					
Power-Up Threshold	$V_S$ rising		2.1		V
Power-Down Threshold	$V_S$ falling		1.7		V
<b>TEMPERATURE RANGE</b>					
Specified Performance Range		-40		+125	$^{\circ}\text{C}$
Operational-Degraded Performance Range		-40		+150	$^{\circ}\text{C}$
Thermal Resistance					
MSOP-10, Junction-to-Ambient	$\theta_{\text{JA}}$		150		$^{\circ}\text{C/W}$

- (8)  $I_{\text{REF}}$  current load is typically  $100\mu\text{A}$  while in Shutdown mode. Although the output amplifier is disabled in Shutdown mode, RFO and RGO ( $180\text{k}\Omega$  typical total) remain connected in series between  $V_{\text{FB}}$  and GND while in Shutdown mode. See [Figure 37, Detailed Block Diagram](#), for more information.

**TYPICAL THREE-WIRE APPLICATION CIRCUIT**

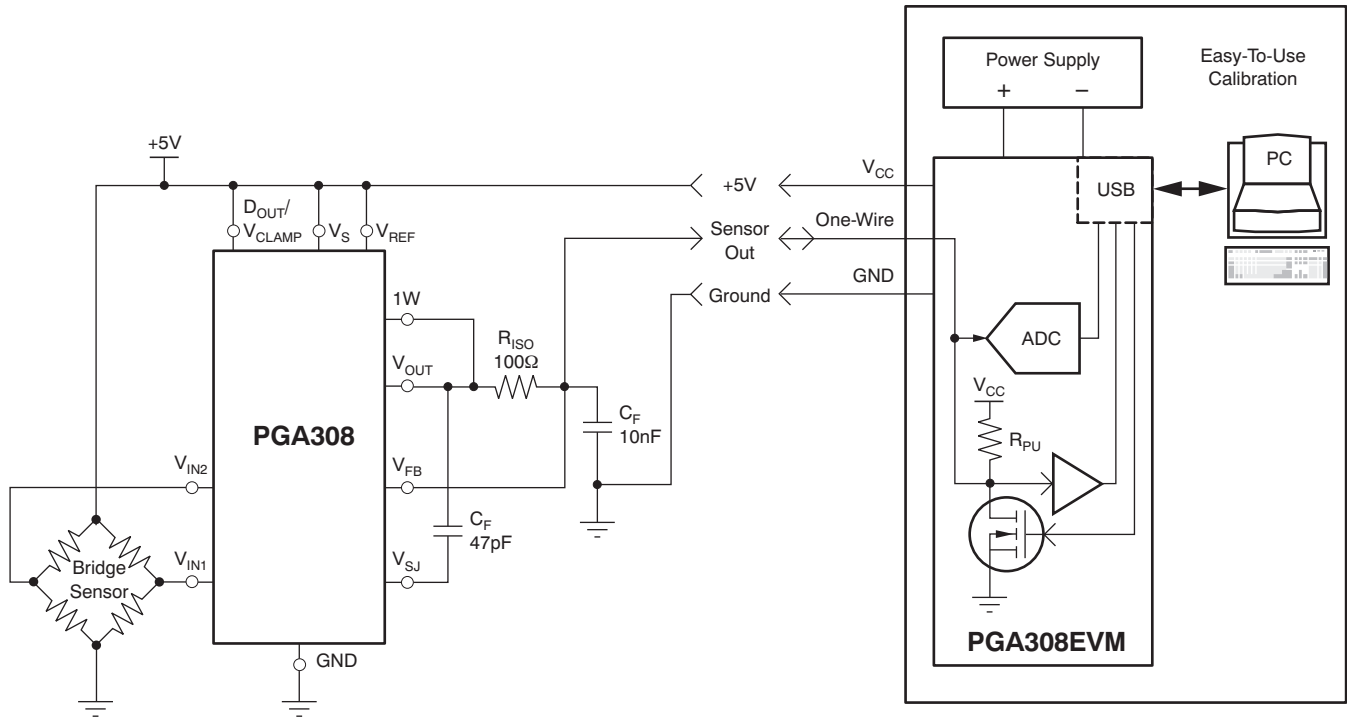

## PIN CONFIGURATIONS



## PIN DESCRIPTIONS

PIN #	NAME	DESCRIPTION
1	$D_{OUT}/V_{CLAMP}$	Dual-use pin: Output voltage clamp limit for $V_{OUT}$ or programmable digital output. The output voltage clamp function is for use in multiple supply systems where the PGA308 may be at $V_S = +5V$ and the system analog-to-digital converter (ADC) is powered at +3V. Setting $V_{CLAMP}$ to +3.2V prevents overvoltage and latch-up on the system ADC input. $V_{CLAMP}$ may be set through a resistor divider from $V_S$ . If configured for digital output, the $D_{OUT}$ function allows for configuration plus calibration of a sensor module either through the One-Wire interface (1W pin) or as a permanently configured module through the power-on reset (POR) OTP memory setting.
2	1W	One-Wire interface program pin. UART interface for digital calibration of the PGA308 over a single wire. Can be connected to $V_{OUT}$ for a three terminal ( $V_S$ , GND, $V_{OUT}$ ) programmable sensor assembly.
3	GND	Ground.
4	$V_S$	+Voltage supply.
5	$V_{IN1}$	Signal input voltage 1. Connect to + or – output of the sensor bridge. Internal multiplexer can change connection internally to front-end PGA.
6	$V_{IN2}$	Signal input voltage 2. Connect to + or – output of the sensor bridge. Internal multiplexer can change connection internally to front-end PGA.
7	$V_{SJ}$	Output amplifier summing junction. Use for output amplifier compensation when driving large capacitive loads (> 200pF) and/or for using external gain setting resistors for the output amplifier.
8	$V_{FB}$	$V_{OUT}$ feedback pin. Voltage feedback sense point for over-/under-scale limit circuitry. If internal gain set resistors for the output amplifier are used, this pin is also the voltage feedback sense point for the output amplifier. $V_{FB}$ in combination with $V_{SJ}$ allows for use of external filter and protection circuits without degrading the PGA308 $V_{OUT}$ accuracy. $V_{FB}$ must always be connected to either $V_{OUT}$ or the point of feedback for $V_{OUT}$ if external filtering is used.
9	$V_{OUT}$	Analog output voltage of conditioned sensor.
10	$V_{REF}$	Reference voltage input pin. $V_{REF}$ is used for coarse offset adjust and Zero DAC. $V_{REF}$ or $V_S$ may be individually selected for over-/under-scale threshold reference and fault monitor comparator reference.



### TYPICAL CHARACTERISTICS

At  $T_A = +25^\circ\text{C}$ ,  $V_S = V_{REF} = D_{OUT}/V_{CLAMP} = +5\text{V}$ ,  $R_L = 10\text{k}\Omega$  and  $C_L = 100\text{pF}$  connected to GND, unless otherwise noted. Gain format is presented:  $G = \text{FE-PGA} \times \text{Fine Gain} \times \text{Output Gain}$ .

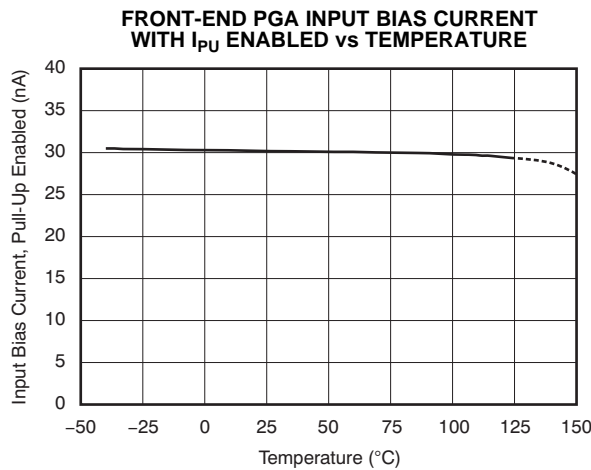

Figure 1.

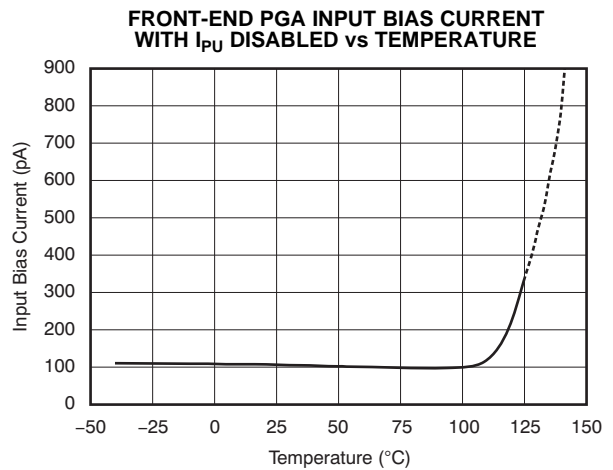

Figure 2.

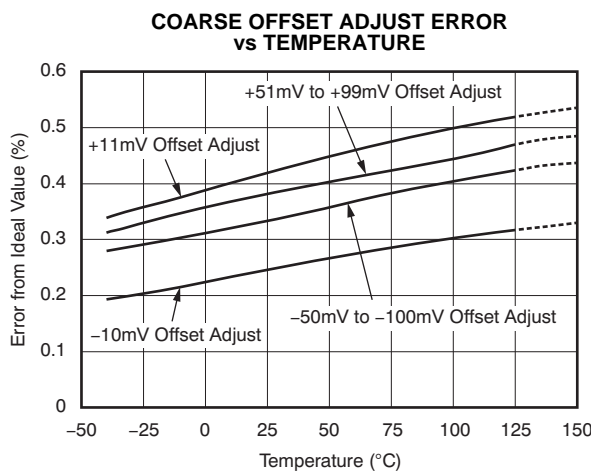

Figure 3.

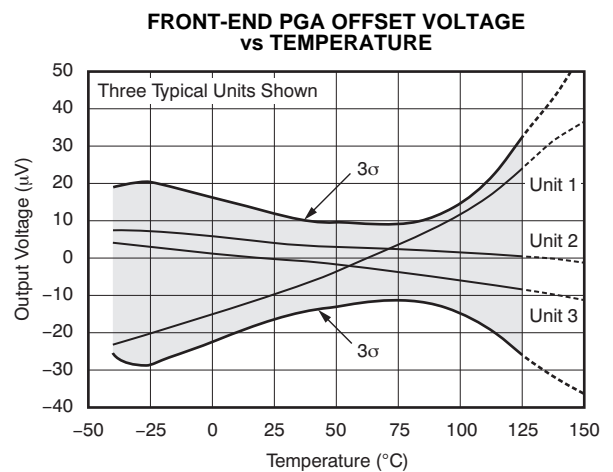

Figure 4.

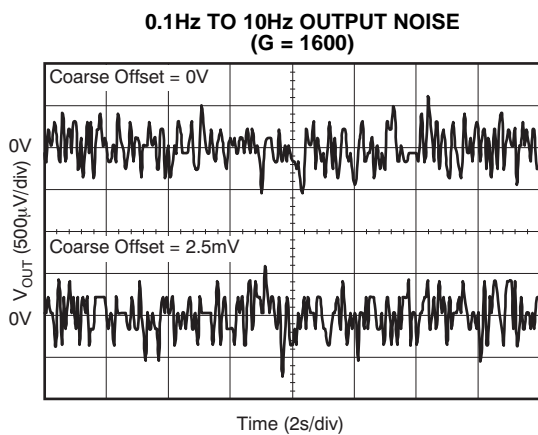

Figure 5.

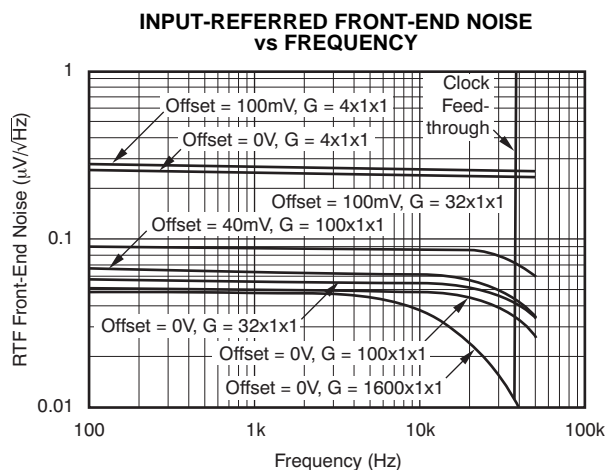

Figure 6.

**TYPICAL CHARACTERISTICS (continued)**

At  $T_A = +25^\circ\text{C}$ ,  $V_S = V_{REF} = D_{OUT}/V_{CLAMP} = +5\text{V}$ ,  $R_L = 10\text{k}\Omega$  and  $C_L = 100\text{pF}$  connected to GND, unless otherwise noted. Gain format is presented:  $G = \text{FE-PGA} \times \text{Fine Gain} \times \text{Output Gain}$ .

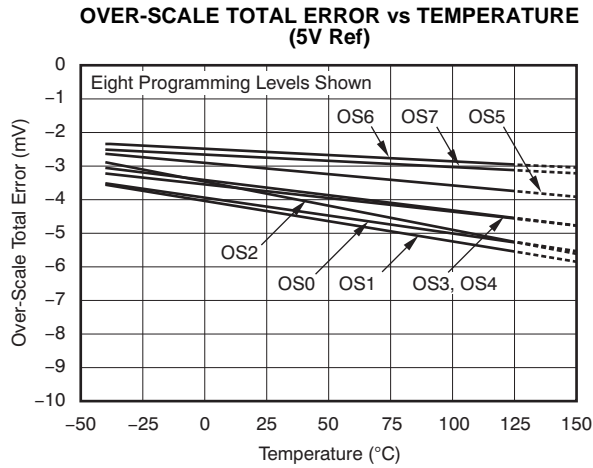

Figure 7.

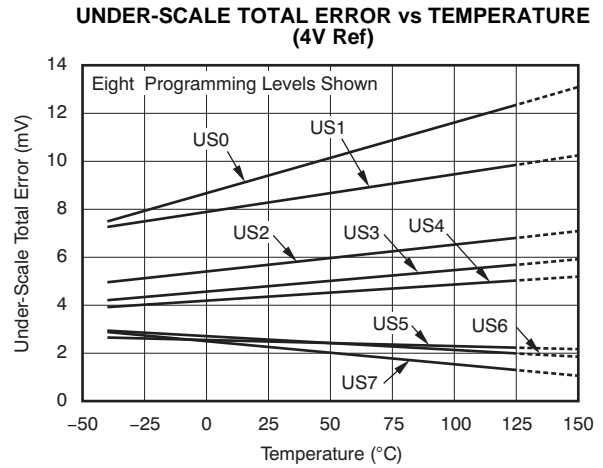

Figure 8.

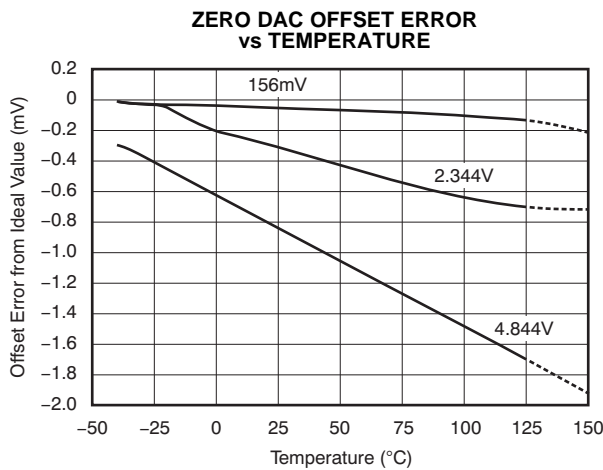

Figure 9.

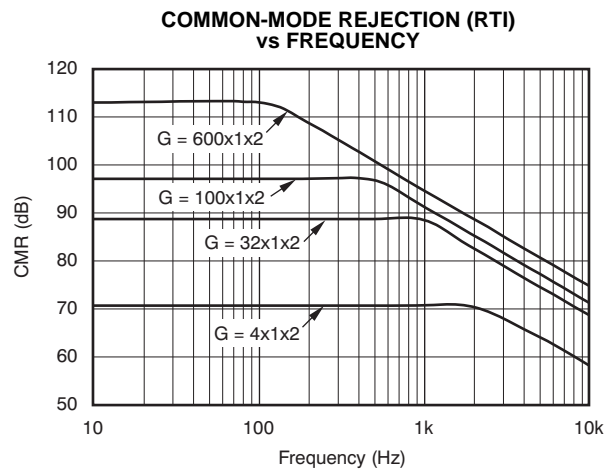

Figure 10.

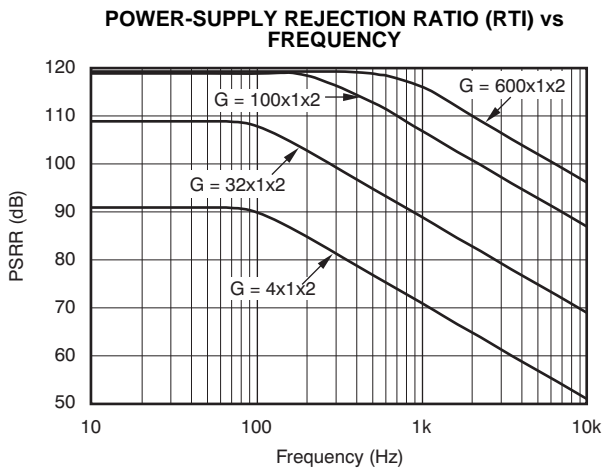

Figure 11.

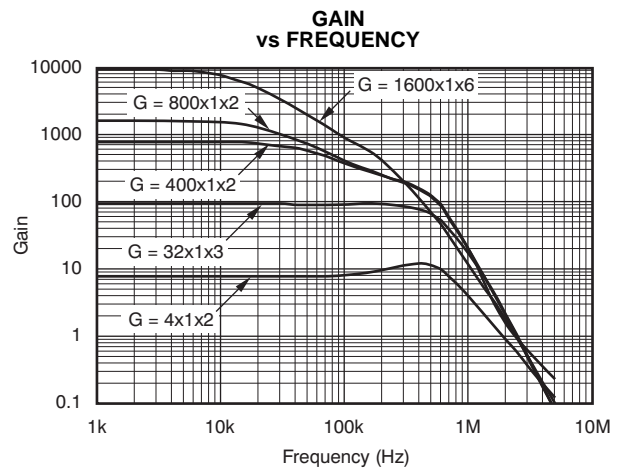

Figure 12.

**TYPICAL CHARACTERISTICS (continued)**

At  $T_A = +25^\circ\text{C}$ ,  $V_S = V_{REF} = D_{OUT}/V_{CLAMP} = +5\text{V}$ ,  $R_L = 10\text{k}\Omega$  and  $C_L = 100\text{pF}$  connected to GND, unless otherwise noted. Gain format is presented:  $G = \text{FE-PGA} \times \text{Fine Gain} \times \text{Output Gain}$ .

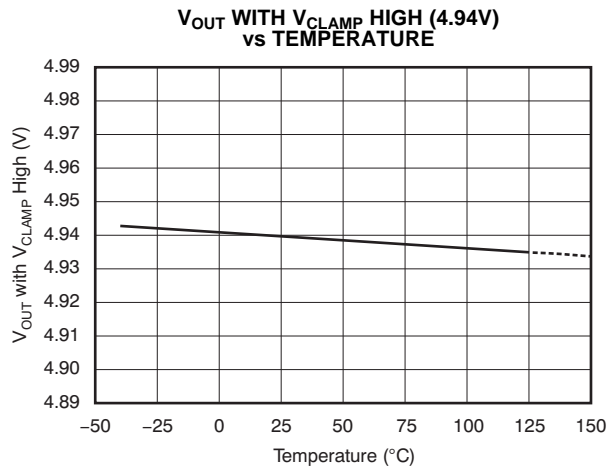

Figure 13.

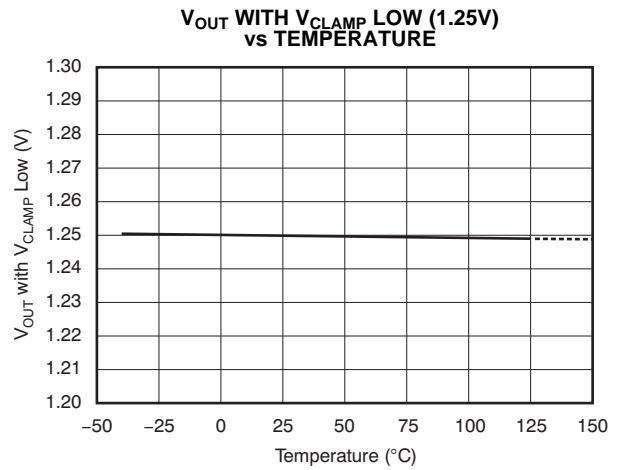

Figure 14.

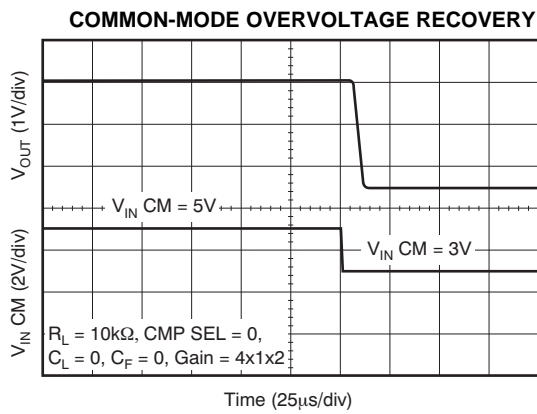

Figure 15.

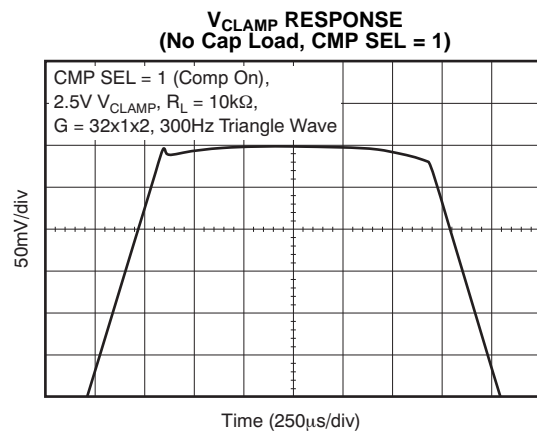

Figure 16.

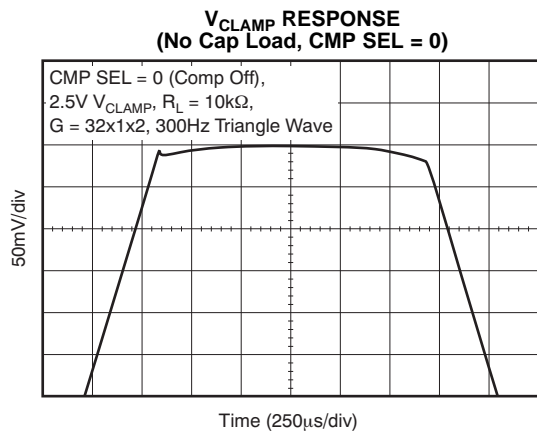

Figure 17.

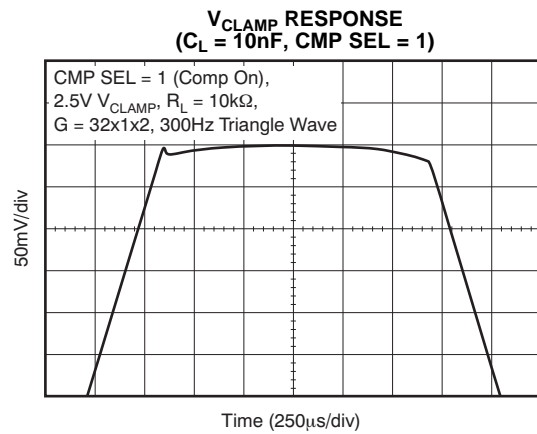

Figure 18.

**TYPICAL CHARACTERISTICS (continued)**

At  $T_A = +25^\circ\text{C}$ ,  $V_S = V_{REF} = D_{OUT}/V_{CLAMP} = +5\text{V}$ ,  $R_L = 10\text{k}\Omega$  and  $C_L = 100\text{pF}$  connected to GND, unless otherwise noted. Gain format is presented:  $G = \text{FE-PGA} \times \text{Fine Gain} \times \text{Output Gain}$ .

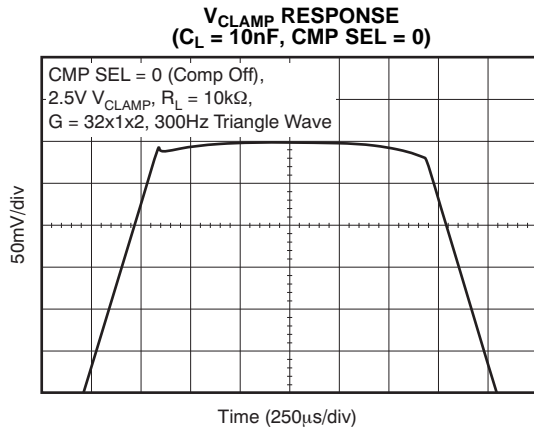

Figure 19.

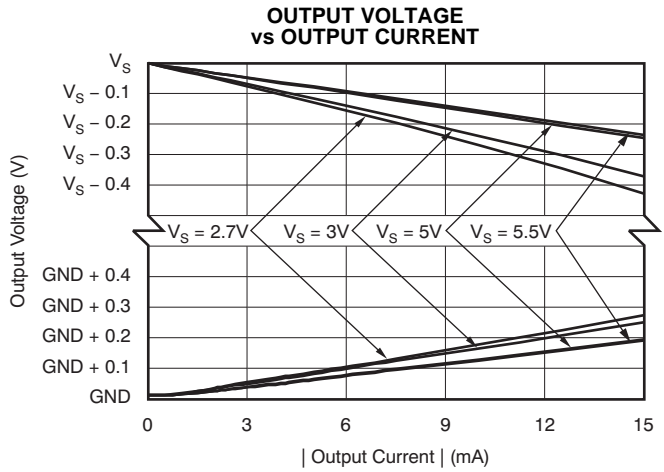

Figure 20.

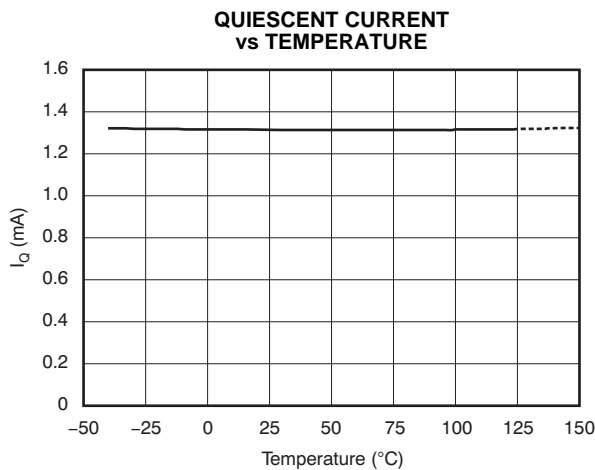

Figure 21.

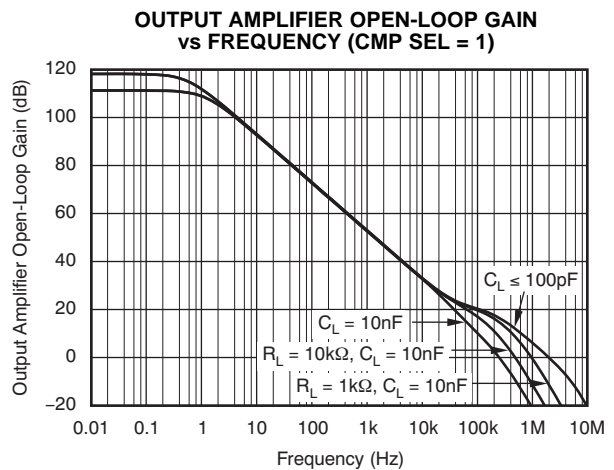

Figure 22.

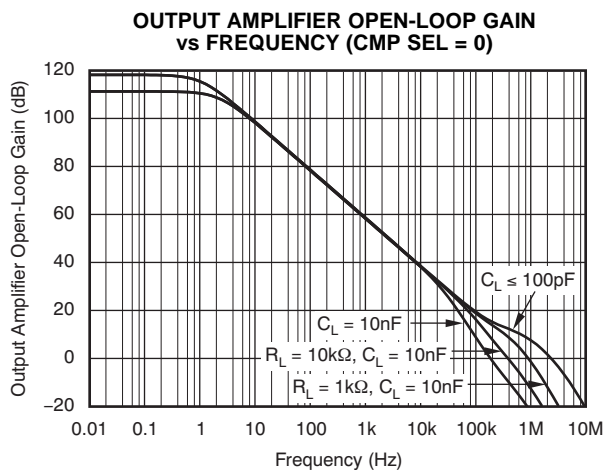

Figure 23.

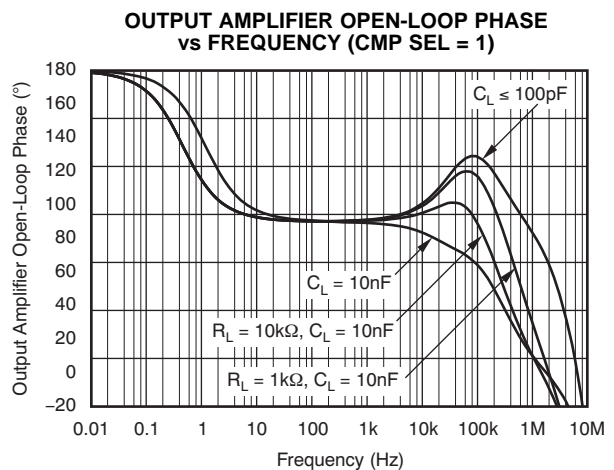

Figure 24.

**TYPICAL CHARACTERISTICS (continued)**

At  $T_A = +25^\circ\text{C}$ ,  $V_S = V_{REF} = D_{OUT}/V_{CLAMP} = +5\text{V}$ ,  $R_L = 10\text{k}\Omega$  and  $C_L = 100\text{pF}$  connected to GND, unless otherwise noted. Gain format is presented:  $G = \text{FE-PGA} \times \text{Fine Gain} \times \text{Output Gain}$ .

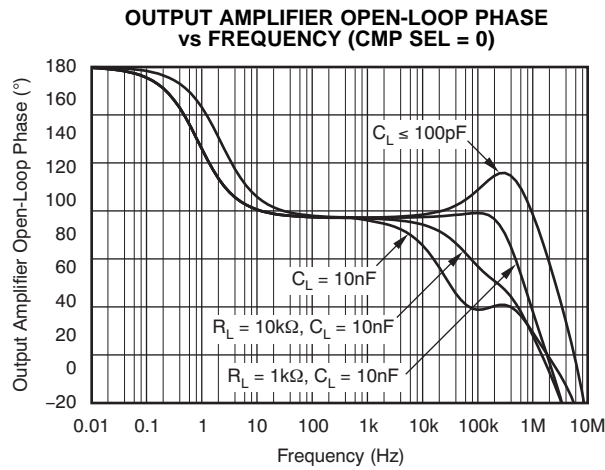

Figure 25.

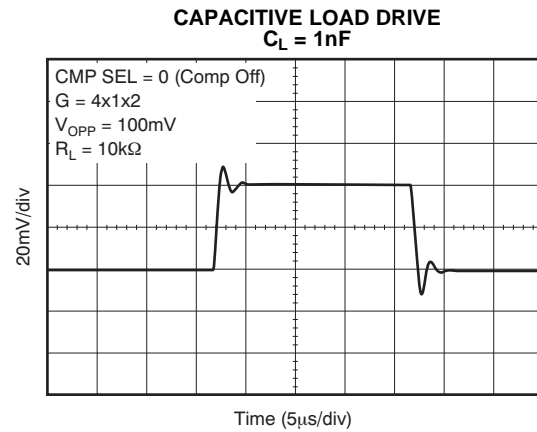

Figure 26.

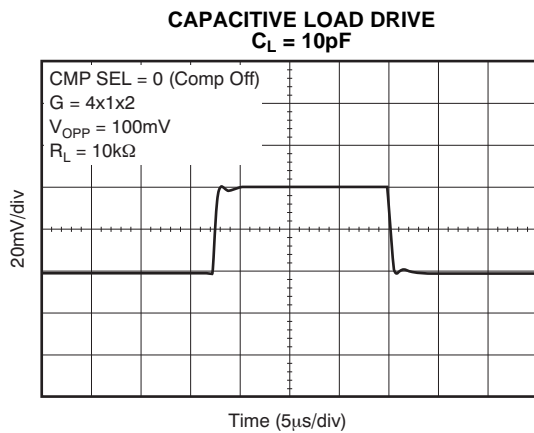

Figure 27.

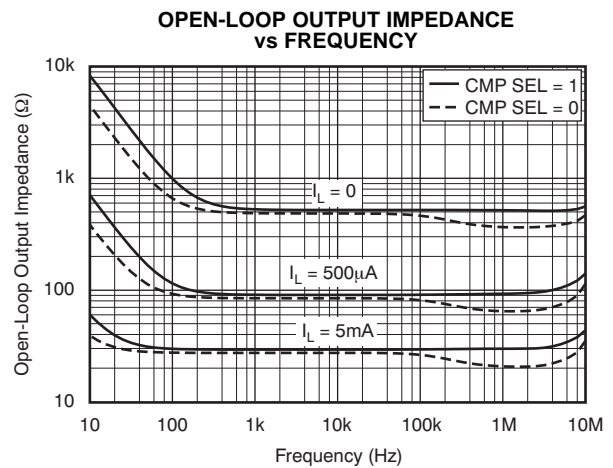

Figure 28.

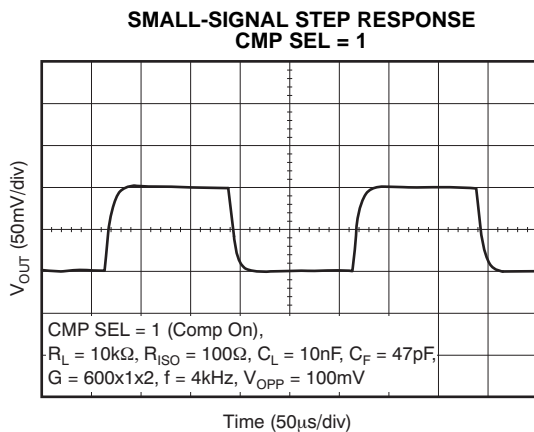

Figure 29.

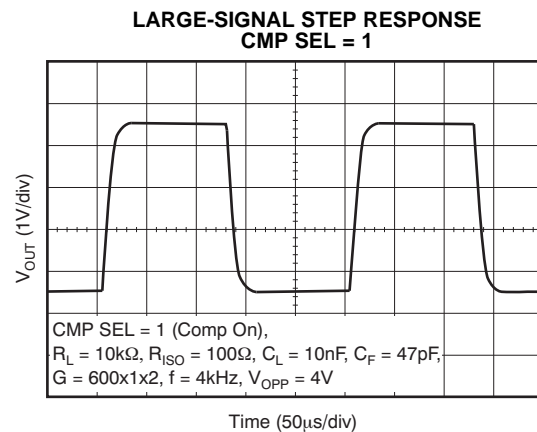
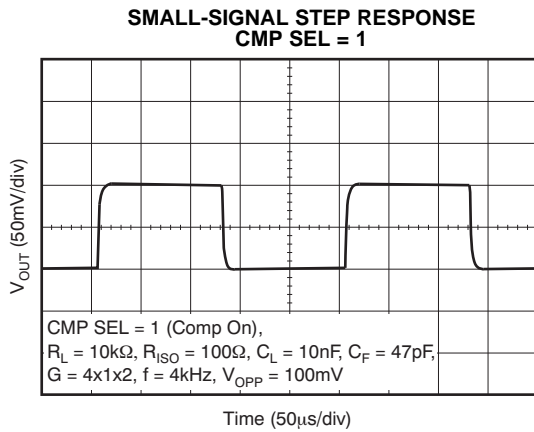

Figure 30.

**TYPICAL CHARACTERISTICS (continued)**

At  $T_A = +25^\circ\text{C}$ ,  $V_S = V_{REF} = D_{OUT}/V_{CLAMP} = +5\text{V}$ ,  $R_L = 10\text{k}\Omega$  and  $C_L = 100\text{pF}$  connected to GND, unless otherwise noted. Gain format is presented:  $G = \text{FE-PGA} \times \text{Fine Gain} \times \text{Output Gain}$ .



**Figure 31.**

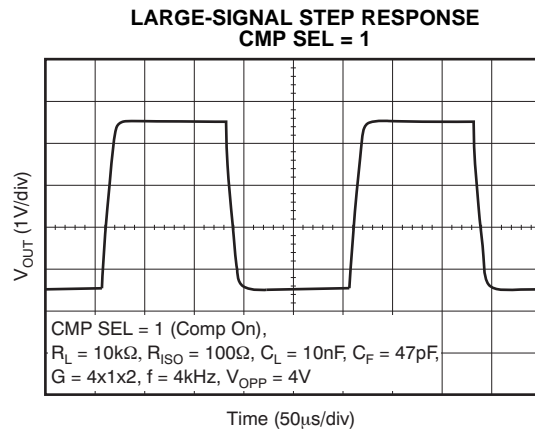

**Figure 32.**

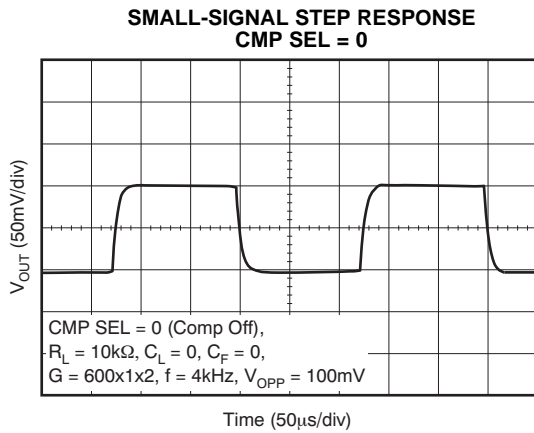

**Figure 33.**

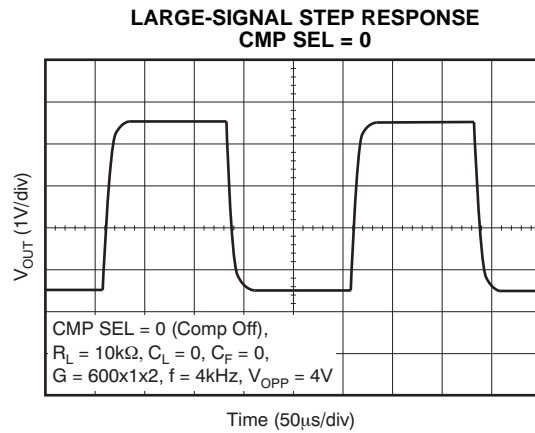

**Figure 34.**

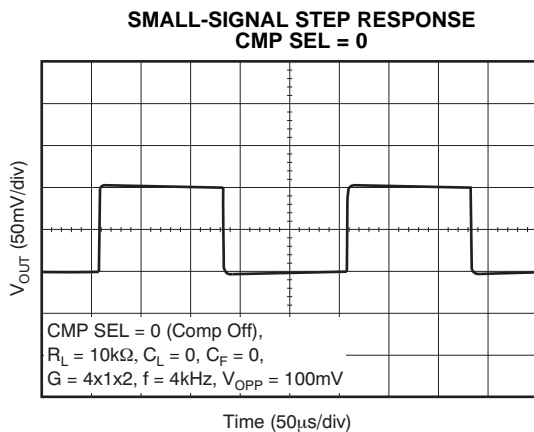

**Figure 35.**

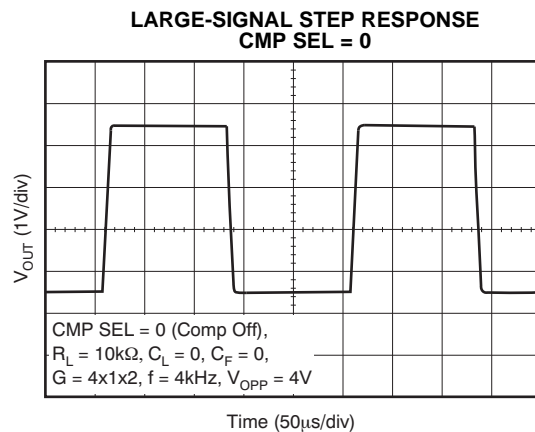

**Figure 36.**

## FUNCTIONAL DESCRIPTION

### OVERVIEW

The PGA308 is an ideal building block for resistive bridge sensor conditioning and general data acquisition. Digitally-programmable coarse offset, fine offset, and gain may be controlled in real time or permanently programmed into the PGA308.

### SENSOR ERROR ADJUSTMENT RANGE

The PGA308 is designed to readily accommodate the following sensors:

Span<sub>25°C</sub>: 0.08mV/V to 296mV/V

Initial Offset: 20mV/V

Span and offset are based on a bridge sensor excitation voltage of +5V, a PGA308 output voltage span of 4V (+0.5V to +4.5V),  $V_{REF}$  of +5V, and a  $V_{OUT}/V_{IN}$  gain up to 9600. For proper PGA308 setup, consider noise, small-signal bandwidth,  $V_{OUT}/V_{IN}$  gain, and required system error.

### AMPLIFICATION SIGNAL PATH

The core of the PGA308 is a precision, low drift, and low noise front-end programmable gain amplifier (PGA). This front-end PGA has gain capabilities from x4 to x1600. The output amplifier has a gain range from x2 to x6. A fine gain adjust in front of the output amplifier offers a selectable x0.33 to x1.0 *attenuation factor*. This architecture yields a  $V_{OUT}/V_{IN}$  gain range for the PGA308 of x2.67 to x9600. Many applications use overall gains of x1600 or less. The selection of gains in the front-end PGA and output amplifier, although capable of up to x9600 overall gain, are intended to allow for gain distribution throughout the PGA308; this design enables optimum span and offset scaling from input to output. The polarity of the inputs can be switched through the input mux to accommodate sensors with unknown polarity output. Higher gains reduce bandwidth and require more analog filtering and/or system analog-to-digital converter (ADC) averaging to reject noise.

### COARSE AND FINE OFFSET ADJUSTMENT

The sensor offset adjustment is done in two stages. The input-referred Coarse Offset Adjust DAC has a  $\pm 100$ mV offset adjustment range for a selected  $V_{REF}$  of +5V. Any residual input sensor offset is corrected and any desired  $V_{OUT}$  offset pedestal for zero-applied sensor strain input is set by a Fine Offset Adjust through the 16-bit Zero DAC that adds to the signal from the output of the front-end PGA.

### VOLTAGE REFERENCE

The PGA308  $V_{REF}$  pin provides input from a reference voltage. The reference voltage is used by the Coarse Offset Adjust and Zero DACs. The fault monitor circuitry trip points, as well as the over- and under-scale limits, can be selected to be referenced to either  $V_S$  or  $V_{REF}$ . This flexibility accommodates absolute or ratiometric mode designs.

### FAULT MONITOR CIRCUIT SENSOR FAULT DETECTION

To detect sensor burnout and/or short, a set of four comparators (external fault comparators) are connected to the inputs of the front-end PGA. There are two fault-detect modes of operation for these comparators.

#### Common-Mode Fault

If either of the inputs are taken outside of the common-mode range of the amplifier [greater than  $(V_S - 1.2V)$ , or less than 100mV], then the corresponding comparator sets a sensor fault flag that can be programmed to drive the PGA308  $V_{OUT}$  to within 100mV ( $I_{OUT} < 4mA$ ) of either  $V_S$  (or  $V_{CLAMP}$  if  $V_{CLAMP}$  is used) or ground. This level is well above the set over-scale limit level or well below the set under-scale limit level. The state of the fault condition can be read in digital form in the ALRM register. If the over-scale/under-scale limiting is disabled, the PGA308 output voltage is also driven within 100mV ( $I_{OUT} < 4mA$ ) of either  $V_S$  (or  $V_{CLAMP}$  if  $V_{CLAMP}$  is used) or ground, depending on the selected fault polarity (high or low).

#### Bridge Fault

To assist in identifying mis-wiring, or open- or short-circuit conditions, the PGA308 provides bridge fault monitoring. For bridge fault detection, either  $V_S$  or  $V_{REF}$  (whichever is used for bridge excitation) can be chosen as  $V_{FLT}$ . If either of the inputs are taken to less than the larger of either 100mV or  $0.35V_{FLT}$ , then a fault is signaled. Also, if either of the inputs is taken to greater than the smaller of  $(V_S - 1.2V)$  or  $0.65V_{FLT}$ , then a fault is signaled. This fault detection allows for operation with bridge differential voltages of up to 30% of the bridge excitation voltage. The corresponding comparator sets a sensor fault flag that can be programmed to drive the PGA308  $V_{OUT}$  to within 100mV ( $I_{OUT} < 4mA$ ) of either  $V_S$  (or  $V_{CLAMP}$  if  $V_{CLAMP}$  is used) or ground. This level is well above the set over-scale limit level or well below the set



under-scale limit level. If over-scale/under-scale limiting is disabled, the PGA308 output voltage is driven within 100mV ( $I_{OUT} < 4mA$ ) of either  $V_S$  or ground, depending on the selected fault polarity (high or low).

### Additional Fault Detection

There are five additional fault detect comparators (internal fault comparators) that help detect subtle PGA308 front-end violations that could result in linear voltages at  $V_{OUT}$  and be interpreted as valid states. These comparators are especially useful during factory calibration and setup.

### Alarm Register

Each of nine fault conditions sets a corresponding bit in the Alarm register. The state of the fault condition can be read digitally from the Alarm register.

### OVER-SCALE AND UNDER-SCALE LIMITS

The over-scale and under-scale limit circuitry provides a programmable upper and lower clip limit for the PGA308 output voltage. When combined with the fault monitor circuitry, system diagnostics can be performed to determine if a conditioned sensor is defective, or if the process being monitored by the sensor is out of range. The selected PGA308  $V_{LIM}$  is divided down by a precision resistor string to form the over- and under-scale trip points. These resistor ratios are extremely accurate and produce no significant initial or temperature errors. An over-scale amplifier driven by the over-scale threshold limits (clips) the maximum PGA308 output,  $V_{OUT}$ . Similarly, an under-scale amplifier driven by the under-scale threshold limits (clips) the minimum PGA308 output,  $V_{OUT}$ . The reference for the trip points,  $V_{LIM}$ , is register-selectable for either  $V_{REF}$  or  $V_S$ .

### $D_{OUT}/V_{CLAMP}$ PIN

The dual-use  $D_{OUT}/V_{CLAMP}$  pin functions either as a  $V_{OUT}$  clamp or as a digital push-pull output. The voltage clamp function provides an output voltage clamp, which is external-resistor programmable. In mixed-voltage systems, where the PGA308 may run from +5V with its output scaled for 0.1V to 2.9V,  $V_{CLAMP}$  can be set to 3.0V to prevent an overvoltage lock-up/latch-up condition on a 3V system ADC or microcontroller input. When programmed as a digital output this pin can be used for sensor module configuration. The value may be pre-programmed in the one-time programmable (OTP) banks, or controlled through the One-Wire interface (1W pin).

### DIGITAL INTERFACE: ONE-WIRE PROGRAM PROTOCOL

The PGA308 can be configured through a single-wire, UART-compatible interface (1W pin). It is possible to connect this single-wire communication pin to the  $V_{OUT}$  pin in true three-terminal modules ( $V_S$ , ground, and sensor out) and continue to allow for calibration and configuration programming.

All communication transactions start with an initialization byte transmitted by the controller. This byte (55h) sets the baud rate used for the communication transaction. The baud rate is sensed during the initialization byte of every transaction, and is used throughout the entire transaction. Each transaction may use a different baud rate, if desired. Baud rates of 4.8k to 114k bits/second are supported.

Each communication consists of several bytes of data. Each byte consists of 10-bit periods. The first bit is the start bit and is always '0'. When idle, the 1W pin should always be high. The second through ninth bits are the eight data bits for the byte and are transferred LSB first. The 10th bit is the stop bit and is always '1'.

The second byte is a command/address byte. The last bit in this byte indicates either a read or write at the address selected by the address pointer portion of the byte. Additional data transfer occurs after the command/address byte. The number of bytes and direction of data transfer depend on the command byte. For a read sequence, the PGA308 waits for a 2-bit delay (unless programmed otherwise) after the completion of the command/address byte before beginning to transmit. This wait allows time for the controller to ensure that the PGA308 is able to control the One-Wire interface. The first byte transmitted by the PGA308 is the least significant byte of the register and the second byte will be the most significant byte of the register.

The recommended circuit implementation is to use a pull-up resistor and/or current source with an open drain (or open collector) output connected to the 1W pin, which is also an open drain output. The single wire can be driven high by the controller during transmit from the controller, but some form of pull-up is required to allow the signal to go high during receive because the PGA308 1W pin can only pull the output low.

### Timeout on the One-Wire Interface

The PGA308 includes a timeout mechanism. If synchronization between the controller and the PGA308 is lost for any reason, the timeout mechanism allows the One-Wire interface to reset communication. The timeout period is set to approximately 28ms (typical). If the timeout period expires between the initialization byte and the



command byte, between the command byte and any data byte, or between any data bytes, the PGA308 resets the One-Wire interface circuitry so that it expects an initialization byte. Every time that a byte is transmitted on the single wire interface, this timeout period restarts.

## POWER-ON SEQUENCE

The PGA308 provides circuitry to detect when the power supply is applied to the PGA308 and resets the internal registers to a known power-on reset (POR) state. This reset also occurs whenever the supply is invalid so that the PGA308 is set to a known state when the supply becomes valid again. The threshold for this circuit is approximately 1.7V to 2.1V. After the power supply becomes valid, the PGA308 waits for approximately 25ms, during which  $V_{OUT}$  is disabled, and then attempts to read the data from the last valid OTP memory bank. If the memory bank has the proper checksum, then the PGA308 RAM is loaded with the OTP data and  $V_{OUT}$  enabled. If the checksum is invalid,  $V_{OUT}$  is set to disabled. Unless disabled by the OWD bit in Configuration Register 2 (CFG2), the One-Wire interface can always communicate to the PGA308 and override the contents of the current RAM in use by setting the appropriate SWL[2:0] bits in the Software Control Register (SFTC). For applications that require *instant-on* for  $V_{OUT}$ , the NOW bit in the CFG2 register can be set to '1', which eliminates the 25ms disable of  $V_{OUT}$  on power-up.

## ONE-WIRE OPERATION WITH 1W CONNECTED TO $V_{OUT}$

In some sensor applications, it is desired to provide the end user of the sensor module with three pins:  $V_S$ , GND, and Sensor Out. It is also desired in these applications to digitally calibrate the sensor module after its final assembly of sensor and electronics. The PGA308 has a mode that allows the One-Wire interface pin (1W) to be tied directly to the PGA308 output pin ( $V_{OUT}$ ).

To calibrate the PGA308 in Three-Wire configuration, program the internal registers and measure the resulting  $V_{OUT}$ . To do this while  $V_{OUT}$  is connected to 1W requires the ability to enable and disable  $V_{OUT}$ . Thus, the 1W/ $V_{OUT}$  line operates in a multiplexed mode where 1W is used as a bidirectional digital interface while  $V_{OUT}$  is disabled, and  $V_{OUT}$  drives the line as a conditioned sensor output voltage when it is enabled.

The PGA308 also provides a mode in which the output amplifier can be enabled for a set time period and then disabled again to allow sharing of the 1W pin with the  $V_{OUT}$  connection. This action is accomplished by writing a value to bits OEN[7:0] in the One-Wire Enable Control register (OENC). Any non-zero value enables the output. This non-zero value is decremented every 10ms until it becomes zero. When this value becomes zero,  $V_{OUT}$  is disabled and a 1s timeout begins waiting for bus activity on the digital interface (1W pin). As long as there is activity on the 1W pin, the 1s timeout is continually reset. After 1s of no bus activity, the PGA308 checks for a correct checksum. If the checksum is correct, the PGA308 runs with the values that currently exist in RAM. If the checksum is not valid, the PGA308 checks for written bank select registers in OTP in the order of BANK SEL4, BANK SEL3, BANK SEL2 then BANK SEL1. The highest bank select register containing valid programmed data is read. The value read from this register points to one of the seven OTP banks, which is then loaded into RAM.

## OTP MEMORY BANKS

There are four one-time programmable (OTP) bank selection registers: BANK SEL1, BANK SEL2, BANK SEL3, and BANK SEL4. Bank selection may be set four times by programming the BANK SELx registers in order (1, 2, 3, 4). The default OTP bank used on POR is the location stored in the last programmed BANK SELx register. Therefore, if programmed, BANK SEL4 always has priority over lower-numbered bank select registers.

The PGA308 contains seven OTP user memory banks. All seven of these banks may be independently programmed. However, the default bank at POR can be set only four times. The seven possible OTP user memory banks allow an end product with a microcontroller interface between the end-user and the PGA308 to select from up to seven factory pre-programmed configurations. It also provides total user flexibility for any other configuration through software communication over the One-Wire interface (1W pin). This flexibility allows no-scrap recovery from miscalibration situations.

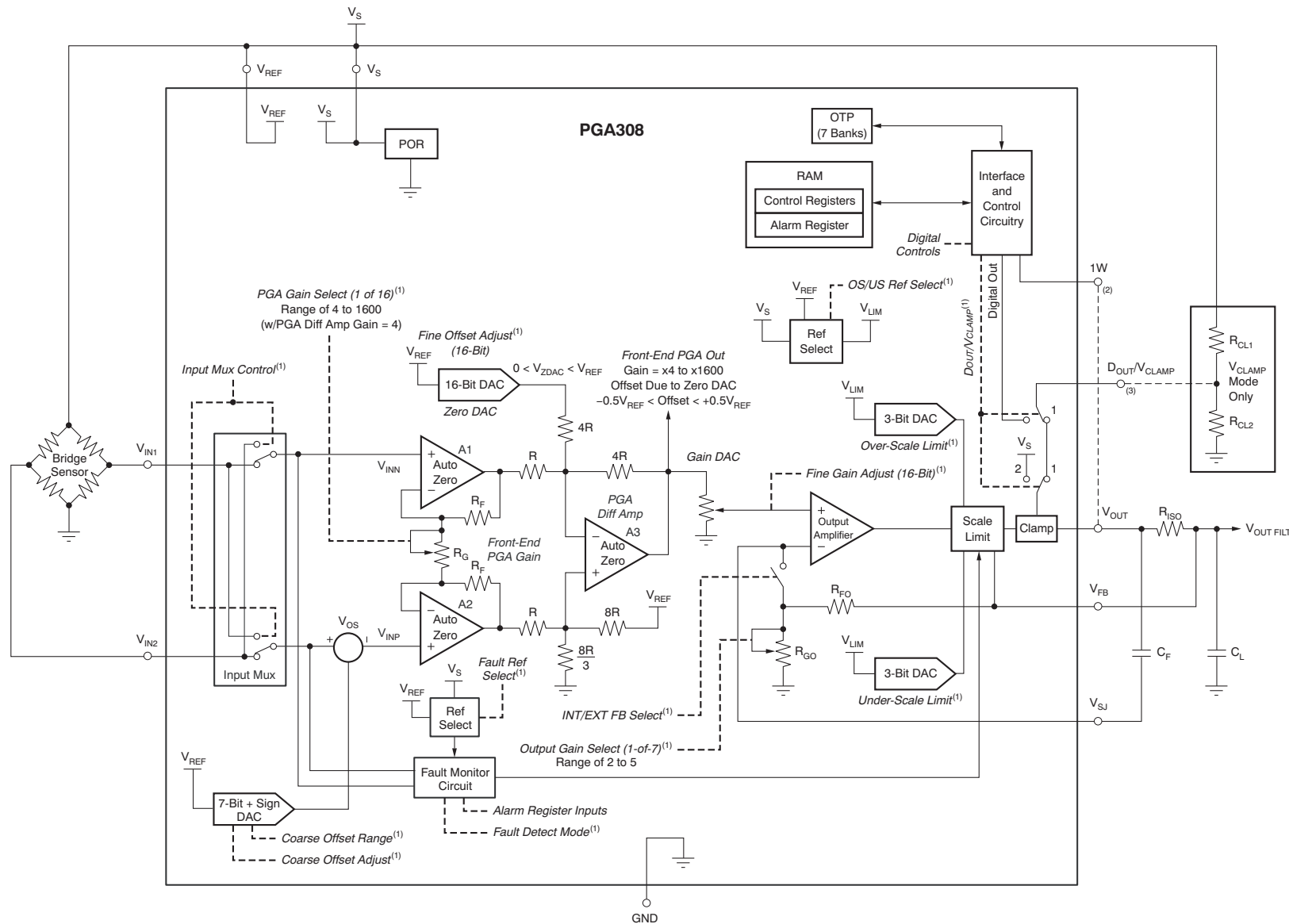

- NOTES:** (1) User-adjustable feature.  
 (2) Optional connection; see the *One-Wire Operation with 1W Connected to  $V_{OUT}$*  section for more information.  
 (3) Optional connection; see the PGA308 User's Guide for more information.

**Figure 37. Detailed Block Diagram**

**PACKAGING INFORMATION**

Orderable Device	Status <sup>(1)</sup>	Package Type	Package Drawing	Pins	Package Qty	Eco Plan <sup>(2)</sup>	Lead/Ball Finish	MSL Peak Temp <sup>(3)</sup>
PGA308AIDGSR	ACTIVE	MSOP	DGS	10	2500	Green (RoHS & no Sb/Br)	CU NIPDAU	Level-2-260C-1 YEAR
PGA308AIDGST	ACTIVE	MSOP	DGS	10	250	Green (RoHS & no Sb/Br)	CU NIPDAU	Level-2-260C-1 YEAR
PGA308AIDRKR	PREVIEW	SON	DRK	10	3000	TBD	Call TI	Call TI
PGA308AIDRKT	PREVIEW	SON	DRK	10	250	TBD	Call TI	Call TI

<sup>(1)</sup> The marketing status values are defined as follows:

**ACTIVE:** Product device recommended for new designs.

**LIFEBUY:** TI has announced that the device will be discontinued, and a lifetime-buy period is in effect.

**NRND:** Not recommended for new designs. Device is in production to support existing customers, but TI does not recommend using this part in a new design.

**PREVIEW:** Device has been announced but is not in production. Samples may or may not be available.

**OBSOLETE:** TI has discontinued the production of the device.

<sup>(2)</sup> Eco Plan - The planned eco-friendly classification: Pb-Free (RoHS), Pb-Free (RoHS Exempt), or Green (RoHS & no Sb/Br) - please check <http://www.ti.com/productcontent> for the latest availability information and additional product content details.

**TBD:** The Pb-Free/Green conversion plan has not been defined.

**Pb-Free (RoHS):** TI's terms "Lead-Free" or "Pb-Free" mean semiconductor products that are compatible with the current RoHS requirements for all 6 substances, including the requirement that lead not exceed 0.1% by weight in homogeneous materials. Where designed to be soldered at high temperatures, TI Pb-Free products are suitable for use in specified lead-free processes.

**Pb-Free (RoHS Exempt):** This component has a RoHS exemption for either 1) lead-based flip-chip solder bumps used between the die and package, or 2) lead-based die adhesive used between the die and leadframe. The component is otherwise considered Pb-Free (RoHS compatible) as defined above.

**Green (RoHS & no Sb/Br):** TI defines "Green" to mean Pb-Free (RoHS compatible), and free of Bromine (Br) and Antimony (Sb) based flame retardants (Br or Sb do not exceed 0.1% by weight in homogeneous material)

<sup>(3)</sup> MSL, Peak Temp. -- The Moisture Sensitivity Level rating according to the JEDEC industry standard classifications, and peak solder temperature.

**Important Information and Disclaimer:**The information provided on this page represents TI's knowledge and belief as of the date that it is provided. TI bases its knowledge and belief on information provided by third parties, and makes no representation or warranty as to the accuracy of such information. Efforts are underway to better integrate information from third parties. TI has taken and continues to take reasonable steps to provide representative and accurate information but may not have conducted destructive testing or chemical analysis on incoming materials and chemicals. TI and TI suppliers consider certain information to be proprietary, and thus CAS numbers and other limited information may not be available for release.

In no event shall TI's liability arising out of such information exceed the total purchase price of the TI part(s) at issue in this document sold by TI to Customer on an annual basis.

**TAPE AND REEL INFORMATION**



**QUADRANT ASSIGNMENTS FOR PIN 1 ORIENTATION IN TAPE**



\*All dimensions are nominal

Device	Package Type	Package Drawing	Pins	SPQ	Reel Diameter (mm)	Reel Width W1 (mm)	A0 (mm)	B0 (mm)	K0 (mm)	P1 (mm)	W (mm)	Pin1 Quadrant
PGA308AIDGSR	MSOP	DGS	10	2500	330.0	12.4	5.3	3.3	1.3	8.0	12.0	Q1
PGA308AIDGST	MSOP	DGS	10	250	180.0	12.4	5.3	3.3	1.3	8.0	12.0	Q1

**TAPE AND REEL BOX DIMENSIONS**



\*All dimensions are nominal

Device	Package Type	Package Drawing	Pins	SPQ	Length (mm)	Width (mm)	Height (mm)
PGA308AIDGSR	MSOP	DGS	10	2500	370.0	355.0	55.0
PGA308AIDGST	MSOP	DGS	10	250	195.0	200.0	45.0

DRK (S-PDSO-N10)

PLASTIC SMALL OUTLINE

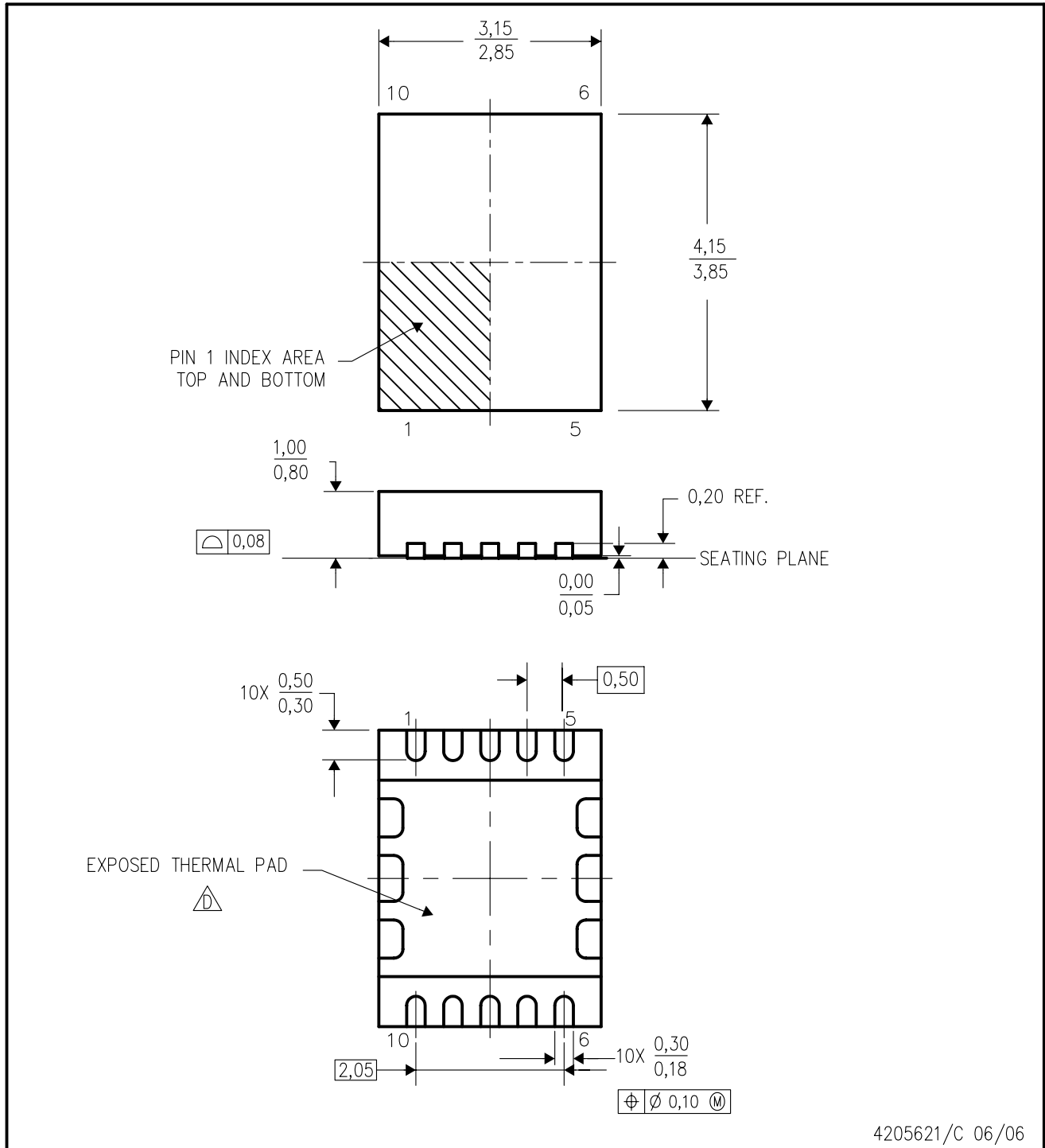

4205621/C 06/06

- NOTES:
- A. All linear dimensions are in millimeters. Dimensioning and tolerancing per ASME Y14.5-1994.
  - B. This drawing is subject to change without notice.
  - C. Small Outline No-Lead (SON) package configuration.
  -  D. The package thermal pad must be soldered to the board for thermal and mechanical performance. See the Product Data Sheet for details regarding the exposed thermal pad dimensions.

DGS (S-PDSO-G10)

PLASTIC SMALL-OUTLINE PACKAGE

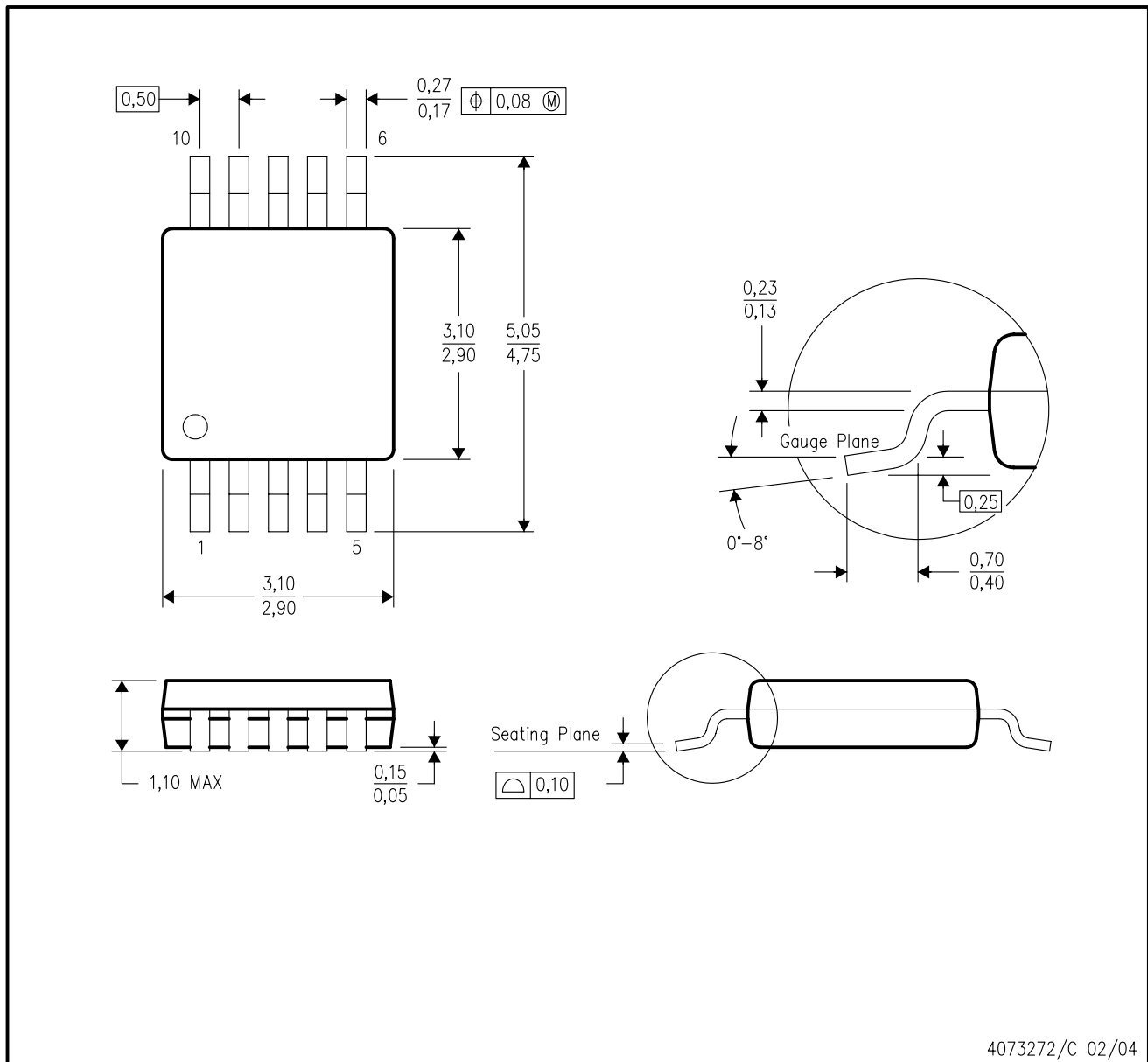

- NOTES:
- A. All linear dimensions are in millimeters.
  - B. This drawing is subject to change without notice.
  - C. Body dimensions do not include mold flash or protrusion.
  - D. Falls within JEDEC MO-187 variation BA.

## IMPORTANT NOTICE

Texas Instruments Incorporated and its subsidiaries (TI) reserve the right to make corrections, modifications, enhancements, improvements, and other changes to its products and services at any time and to discontinue any product or service without notice. Customers should obtain the latest relevant information before placing orders and should verify that such information is current and complete. All products are sold subject to TI's terms and conditions of sale supplied at the time of order acknowledgment.

TI warrants performance of its hardware products to the specifications applicable at the time of sale in accordance with TI's standard warranty. Testing and other quality control techniques are used to the extent TI deems necessary to support this warranty. Except where mandated by government requirements, testing of all parameters of each product is not necessarily performed.

TI assumes no liability for applications assistance or customer product design. Customers are responsible for their products and applications using TI components. To minimize the risks associated with customer products and applications, customers should provide adequate design and operating safeguards.

TI does not warrant or represent that any license, either express or implied, is granted under any TI patent right, copyright, mask work right, or other TI intellectual property right relating to any combination, machine, or process in which TI products or services are used. Information published by TI regarding third-party products or services does not constitute a license from TI to use such products or services or a warranty or endorsement thereof. Use of such information may require a license from a third party under the patents or other intellectual property of the third party, or a license from TI under the patents or other intellectual property of TI.

Reproduction of TI information in TI data books or data sheets is permissible only if reproduction is without alteration and is accompanied by all associated warranties, conditions, limitations, and notices. Reproduction of this information with alteration is an unfair and deceptive business practice. TI is not responsible or liable for such altered documentation. Information of third parties may be subject to additional restrictions.

Resale of TI products or services with statements different from or beyond the parameters stated by TI for that product or service voids all express and any implied warranties for the associated TI product or service and is an unfair and deceptive business practice. TI is not responsible or liable for any such statements.

TI products are not authorized for use in safety-critical applications (such as life support) where a failure of the TI product would reasonably be expected to cause severe personal injury or death, unless officers of the parties have executed an agreement specifically governing such use. Buyers represent that they have all necessary expertise in the safety and regulatory ramifications of their applications, and acknowledge and agree that they are solely responsible for all legal, regulatory and safety-related requirements concerning their products and any use of TI products in such safety-critical applications, notwithstanding any applications-related information or support that may be provided by TI. Further, Buyers must fully indemnify TI and its representatives against any damages arising out of the use of TI products in such safety-critical applications.

TI products are neither designed nor intended for use in military/aerospace applications or environments unless the TI products are specifically designated by TI as military-grade or "enhanced plastic." Only products designated by TI as military-grade meet military specifications. Buyers acknowledge and agree that any such use of TI products which TI has not designated as military-grade is solely at the Buyer's risk, and that they are solely responsible for compliance with all legal and regulatory requirements in connection with such use.

TI products are neither designed nor intended for use in automotive applications or environments unless the specific TI products are designated by TI as compliant with ISO/TS 16949 requirements. Buyers acknowledge and agree that, if they use any non-designated products in automotive applications, TI will not be responsible for any failure to meet such requirements.

Following are URLs where you can obtain information on other Texas Instruments products and application solutions:

### Products

Amplifiers	<a href="http://amplifier.ti.com">amplifier.ti.com</a>
Data Converters	<a href="http://dataconverter.ti.com">dataconverter.ti.com</a>
DSP	<a href="http://dsp.ti.com">dsp.ti.com</a>
Clocks and Timers	<a href="http://www.ti.com/clocks">www.ti.com/clocks</a>
Interface	<a href="http://interface.ti.com">interface.ti.com</a>
Logic	<a href="http://logic.ti.com">logic.ti.com</a>
Power Mgmt	<a href="http://power.ti.com">power.ti.com</a>
Microcontrollers	<a href="http://microcontroller.ti.com">microcontroller.ti.com</a>
RFID	<a href="http://www.ti-rfid.com">www.ti-rfid.com</a>
RF/IF and ZigBee® Solutions	<a href="http://www.ti.com/lprf">www.ti.com/lprf</a>

### Applications

Audio	<a href="http://www.ti.com/audio">www.ti.com/audio</a>
Automotive	<a href="http://www.ti.com/automotive">www.ti.com/automotive</a>
Broadband	<a href="http://www.ti.com/broadband">www.ti.com/broadband</a>
Digital Control	<a href="http://www.ti.com/digitalcontrol">www.ti.com/digitalcontrol</a>
Medical	<a href="http://www.ti.com/medical">www.ti.com/medical</a>
Military	<a href="http://www.ti.com/military">www.ti.com/military</a>
Optical Networking	<a href="http://www.ti.com/opticalnetwork">www.ti.com/opticalnetwork</a>
Security	<a href="http://www.ti.com/security">www.ti.com/security</a>
Telephony	<a href="http://www.ti.com/telephony">www.ti.com/telephony</a>
Video & Imaging	<a href="http://www.ti.com/video">www.ti.com/video</a>
Wireless	<a href="http://www.ti.com/wireless">www.ti.com/wireless</a>

Mailing Address: Texas Instruments, Post Office Box 655303, Dallas, Texas 75265  
Copyright © 2008, Texas Instruments Incorporated